

---

# Load Cells

---

A Primer on the Design  
and Use of Strain Gage  
Force Sensors

---

**interface**  
ADVANCED FORCE MEASUREMENT

---

Copyright 1998–2009, Interface Inc. All rights reserved.

INTERFACE, INC. MAKES NO WARRANTY, EITHER EXPRESSED OR IMPLIED, INCLUDING, BUT NOT LIMITED TO, ANY IMPLIED WARRANTIES OF MERCHANTABILITY OR FITNESS FOR A PARTICULAR PURPOSE, REGARDING THESE MATERIALS AND MAKES SUCH MATERIALS AVAILABLE SOLELY ON AN “AS-IS” BASIS.

IN NO EVENT SHALL INTERFACE, INC. BE LIABLE TO ANYONE FOR SPECIAL, COLLATERAL, INCIDENTAL, OR CONSEQUENTIAL DAMAGES IN CONNECTION WITH OR ARISING OUT OF USE OF THESE MATERIALS.

Interface, Inc.  
7401 Butherus Drive  
Scottsdale, AZ 85260

480.948.5555 phone  
480.948.1924 fax

[sales@interfaceforce.com](mailto:sales@interfaceforce.com)  
<http://www.interfaceforce.com>

# Table of Contents

Table of Contents.....	3
THE LOAD CELL PRIMER .....	7
The “Elastic Force Transducer” .....	7
Adding Sophistication.....	8
A Rudimentary Load Cell: The Proving Ring .....	10
Creep.....	10
Deflection Measurement .....	10
Temperature Effects .....	11
Response to Extraneous Forces.....	11
Conclusion.....	11
Improvements on the Proving Ring Idea .....	11
Introducing the Strain Gage.....	11
Thermal Tracking .....	12
Temperature Compensation.....	12
Creep Compensation .....	12
Frequency Response.....	13
Non-Repeatability.....	13
Resolution .....	13
Flexure Configurations: Bending Beams.....	13
Bending Beam Cell.....	13
Double-Ended Bending Beam Cell.....	14
S-Beam Cells.....	14
SMT Overload Protected S-Cell.....	15
LBM and LBT Load Button Cells.....	15
SPI Single Point Impact Cell .....	15
1500 Low Profile Rotated Bending Beam.....	16
Flexure Configurations: Shear Beams.....	17
SSB Shear Beam Cell .....	17
Low Profile Shear Beam Cell .....	17
Extraneous Load Sensitivity .....	19
The Low Profile Precision Series.....	20
The Low Profile Ultra Precision Series.....	20

The Low Profile Fatigue Rated Series.....	20
Fatigue Rated Load Cell.....	21
Compression Loading.....	21
WeighCheck Weighing System.....	22
LoadTrol Oil Well Pump-Off Control Cell.....	23
Competitive Load Cell Product Configurations.....	24
The Simple Column Cell.....	24
Advantages of the LowProfile Cell.....	25
Input/Output Characteristics and Errors.....	26
Gage Interconnection Configurations.....	26
Temperature Effect on Zero and Output.....	27
Load Cell Electrical Output Errors.....	28
Resistance to Extraneous Loads.....	29
System Errors.....	29
GENERAL PROCEDURES FOR THE USE OF LOAD CELLS.....	31
Excitation Voltage.....	31
Remote Sensing of Excitation Voltage.....	32
Physical Mounting: “Dead” and “Live” End.....	33
Mounting Procedures for Beam Cells.....	34
Mounting Procedures for Other Mini Cells.....	34
Mounting Procedures for Low Profile Cells With Bases.....	35
Mounting Procedures for Low Profile Cells Without Bases.....	36
Mounting Torques for Fixtures in Low Profile Cells.....	37
LOAD CELL CHARACTERISTICS AND APPLICATIONS.....	38
Load Cell Stiffness.....	38
Load Cell Natural Frequency: Lightly Loaded Case.....	40
Load Cell Natural Frequency: Heavily Loaded Case.....	42
Contact Resonance.....	43
Application of Calibration Loads: Conditioning the Cell.....	44
Application of Calibration Loads: Impacts and Hysteresis.....	44
Test Protocols and Calibrations.....	44
Application of In-Use Loads: On-Axis Loading.....	45
Control of Off-Axis Loads.....	46
Reducing Extraneous Loading Effects by Optimizing Design.....	46

Overload Capacity with Extraneous Loading .....	46
Impact Loads .....	46
MULTI-CELL STATIC OR WEIGHING APPLICATIONS.....	47
Equalizing the Loads in Multiple-Cell Systems .....	48
Corner Adjustment of Multiple-Cell Systems .....	50
Moment Compensated Platform.....	50
One-Cell Systems .....	51
Two-Cell Systems .....	52
Parallel Paths: Pipes, Conduit, and Check Rods .....	53
Paralleling Two or More Cells.....	53
Universal Cells .....	53
Compression Cells .....	56
MATERIALS AND PROCESS CONTROL TESTING.....	56
Force Versus Deflection.....	57
Shear Force Versus Compaction .....	57
Peel Force .....	58
Adhesive or Bonding Shear Force .....	58
Safety: Proof Testing and the Compression Cage.....	58
Finding Center of Gravity.....	59
FATIGUE TESTING.....	60
Fatigue Capacity.....	60
Use of Non-Fatigued-Rated Cells in Fatigue Applications .....	61
Fatigue Capacity With an Added Fixed Load.....	62



# THE LOAD CELL PRIMER

## The “Elastic Force Transducer”

People have known for centuries that heavy objects deflect a spring support more than light ones. Take, for example, a fly fisherman as he casts his line and catches a fish. The fishing pole is a flexible tapered beam, supported at one end by the fisherman’s grip and deflected at the far end by the force of the line leading down to the fish. If the fish is fighting vigorously, the pole is pulled down quite a bit. If the fish stops fighting, the pole’s deflection is less. As the man pulls the fish out of the water, a heavy fish deflects the pole more than a light one.

This knowledge about the deflection of a springy rod is not confined to the human race. As we watch movies of monkeys in the trees, we realize that they have some understanding of this principle also.



Figure 1. Bending beam deflection.

The phenomenon that is demonstrated in Figure 1 relates to the deflection of a *bending beam* under load. We could also determine the relationship between the deflection of a *coil spring* and the force which causes it. For example, when the fisherman hangs his catch on a fish scale, a heavy fish pulls the scale’s hook down farther than a light one. Inside that fish scale is nothing more complicated than a coil spring, a pointer to mark the position of the end of the spring, and a ruler-like scale to indicate the deflection, and thus the weight of the fish.

We can demonstrate a more exact quantitative relationship by running an experiment. We can calibrate a coil spring of our own choice by clamping the top end of it to a cross bar, connecting a pointer at the lower end of the spring, and mounting a ruler to indicate the deflection as we place weights in a pan hanging from the lower end of the spring.

On our particular scale, we note that the *resolution* of the ruler is 1/20 of an inch, because the marks are 1/10 of an inch apart. This is because we can tell the difference between two readings of about half the distance between the marks.

With no weight in the pan, take a reading of the pointer on the ruler. Next, apply a one pound weight and note that this particular spring is deflected one mark on the ruler from the original reading. Add another weight, and the deflection is one mark more. As we add more weights, we record all the readings. The table is a record of the weight versus deflection data which we recorded.

Weight	Mark
0	0.5
1	1.5
2	2.5
3	3.5
4	4.5

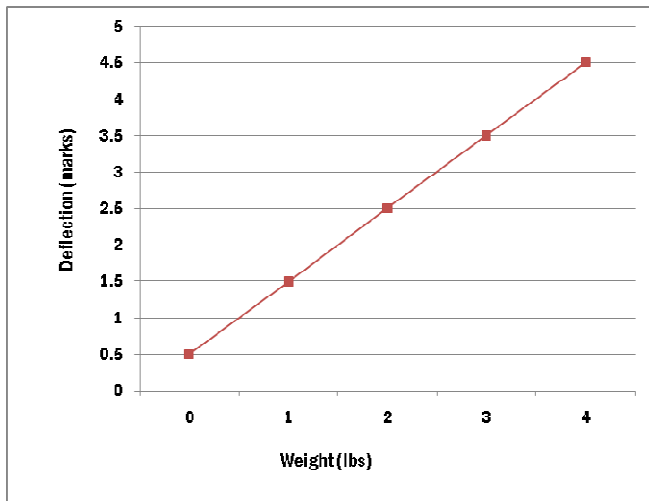

Figure 2. Deflection versus applied weight.

If we plot these data on a graph, we find that we can connect all the points with a single straight line. An algebra or geometry teacher would tell us that the equation of this line is:

$$D = D_0 + \frac{W}{k}$$

Where:

$D$  = Deflection of the spring

$D_0$  = Initial deflection of the spring

$W$  = Weight on pan

$k$  = Stiffness constant of the spring

The idea that the *transfer function* of the spring scale is exactly a straight line occurs to us only because the measurements did not have enough resolution. Our straight line graph is only a rough approximation of the spring's true characteristics.

We have now demonstrated the two basic components of a load cell: a springy element (usually called a *flexure*) which supports the load to be measured, and a deflection measuring element which indicates the deflection of the flexure resulting from the application of loads.

## Adding Sophistication

We can improve the resolution of the measurements by replacing the ruler with a micrometer having a fine-thread screw, so that we can resolve one-thousandths or even one ten-thousandths of an inch. Now, as we re-run the experiment, we can easily see, by simple visual inspection of the data, that it will not exactly fit on a straight line.

Weight	Mark
0	0.500
1	1.509
2	2.516
3	3.511
4	4.495

When we look closely at the deviation of the data from our hoped-for straight line, we can see that the differences are so small that they are less than the thickness of the



characteristics. Therefore, in order to present the data in a meaningful form, it is necessary to modify our classical idea about the graphing of data. We will need to magnify the scaling of the graph in such a way that the deviations from a straight line are easier to see.

Rather than graphing “Weight” versus “Deflection,” we can plot “Weight” versus “Deviation from a Straight Line.” Then, it becomes necessary to choose which straight line to use as a reference. One common choice is the “End Points Straight Line,” which is the line passing through the point at zero load and the point at maximum load.

As you can see in Figure 3, the horizontal axis represents the straight line we have chosen to use as a reference. But, notice, we have given up the scaling information about the spring. We can’t calculate the “pounds per inch” constant of the spring from the graphed information. Therefore, for the graph to be most useful, we should print the scaling constant somewhere on the graph.

Also, if we choose “Deviation” for the vertical axis, it is not too useful, since we can’t relate the numbers to the performance of the spring without dividing all the numbers by the full scale output range of the test. We can help the user of the graph by performing that division ahead of time, converting the units on the vertical axis to “Percent of Full Scale.” In our example, we would divide all the deviation numbers by 4.495 (that is:  $4.995 - 0.500$ ), the range of the test outputs from no load to full load.

By using “Percent of Full Scale,” we can easily compare the performance of many springs in a way which lets us select the ones which have the characteristics we want. Later on, we will see that springs have many more parameters than just the simple spring constant which was presented earlier in the deflection equation for springs.

You will notice that our new graph in Figure 3 gives us a much clearer picture of the true characteristics of the spring over the range of interest.

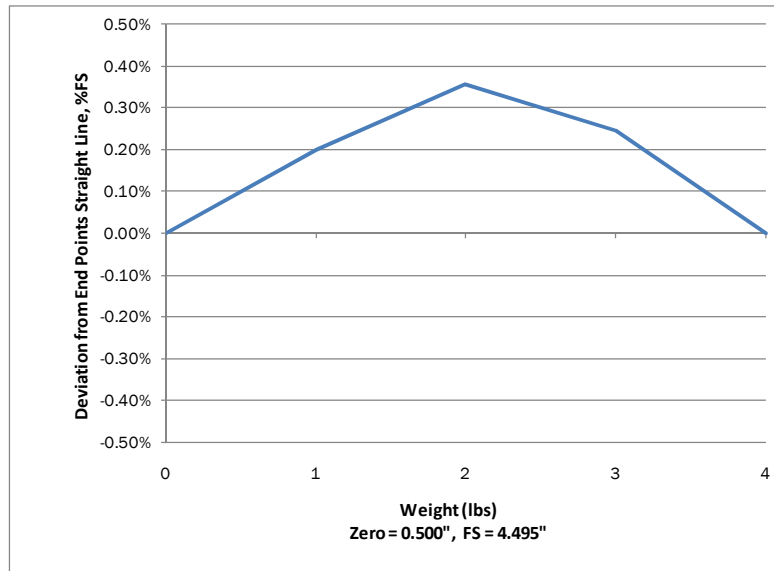

Figure 3. Deviation from straight line versus applied weight.

## A Rudimentary Load Cell: The Proving Ring



Figure 4. Proving ring.

Decades ago, the Proving Ring was conceived as a device to be used for the calibration of force measuring dial gages. It consisted of a steel ring with a micrometer mounted so as to measure the vertical deflection when loads were applied through the threaded blocks at the top and bottom.

For many years proving rings were considered the standard of excellence for force calibration. However, they suffer from the following adverse characteristics:

### Creep

All solid materials exhibit a very small instantaneous elongation if a force is applied in tension. For compressive forces, the material will become slightly shorter. However, if we maintain the same force and continue to measure the length, we will see that the length continues to change slightly. If we plot the change in length versus time, we will arrive at the graph of Figure 5, which shows *creep*, and also shows *creep recovery* when the force is removed.

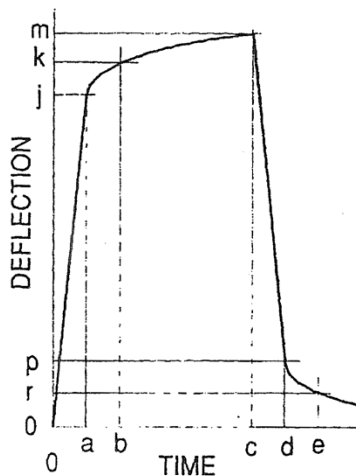

Figure 5. Creep versus time.

A tool steel ring, such as the proving ring, has creep of about 0.25% of the applied force in the first 20 minute interval after application of the force. Referring to Figure 5, the force is applied from zero time to time “a.” The initial deflection is “j,” and then we see a rapid initial increase in length, followed by length “k” at time “b” and length “m” at time “c.” Note that, although the time “a to b” is equal to the time “b to c,” the increase in length “j to k” is much greater than the increase “k to m.” (The creep scaling is exaggerated in Figure 5, to demonstrate the principle.)

If we were to run a test for a much longer time, even weeks, we would continue to see a continuing but decreasing rate of creep, provided our measuring system had enough resolution to be able to detect extremely small deflections. Creep recovery follows a curve similar to the creep curve, but in a reverse sense.

### Deflection Measurement

When forces are applied to the proving ring, it departs from its circular shape and becomes slightly egg-shaped. The determination of the deflection of a proving ring depends on the subtraction of two large numbers, namely, the inside diameter of the proving ring and the length of the micrometer measurement assembly. Since the difference is so small, any slight error in measuring either dimension leads to a large percentage error in the number at interest, the deflection.

Any mechanical deflection measurement system introduces errors which are difficult to control or overcome. The most obvious problem is **resolution**, which is limited by the fineness of the micrometer threads and the spacing of the indicator marks. **Nonrepeatability** of duplicate measurements taken in the same direction depends mainly on how much force is applied to the micrometer's screw threads, while **hysteresis** of measurements taken at the same point from opposite directions is dependent on the preload, friction, and looseness in the threads.

### **Temperature Effects**

Variation in the temperature of either the steel ring or the micrometer assembly will cause expansion or contraction, which will result in a change in the deflection reading. A first order correction would be to make all the parts out of the same material, so that their relative temperature effects are equal, causing them to cancel each other out. Unfortunately, this presumes that all the parts track each other in temperature, and this is not true in practice. A light shining on one side of the ring or a warm breeze from a furnace vent will cause differential warming, and a proving ring is very susceptible to temperature gradients in the proving ring mechanism. Also, the spring constant changes with temperature, thus changing the calibration.

### **Response to Extraneous Forces**

The construction of a proving ring does not lend itself to the cancellation of extraneous forces, such as side loads, torque loads and moment loads. Any load other than a pure force through the sensitive axis of the ring can result in an extraneous output.

### **Conclusion**

The proving ring requires specially trained personnel for proper operation because of the possibility of errors introduced by creep, and it is also subject to errors due to temperature and extraneous loads.

### **Improvements on the Proving Ring Idea**

By now, it is obvious that the deflection measurement element would need to be changed dramatically to achieve a practical load cell with the desired characteristics. The element needs to be smaller and it needs to be in intimate thermal contact with the flexure, so that their temperatures will track closely. It needs to have better resolution. It should be rugged and simple to operate.

### **Introducing the Strain Gage**

It is a well-known fact that the resistance of a length of wire will increase if we stretch it. Figure 6 shows an exaggerated view of a wire segment of length  $L_1$  and diameter  $D_1$ . When it is stretched, it assumes length  $L_2$ , and the diameter becomes  $D_2$  (smaller) to maintain the same volume in the piece. Of course, the smaller diameter of the wire means that its resistance per unit length will be higher.

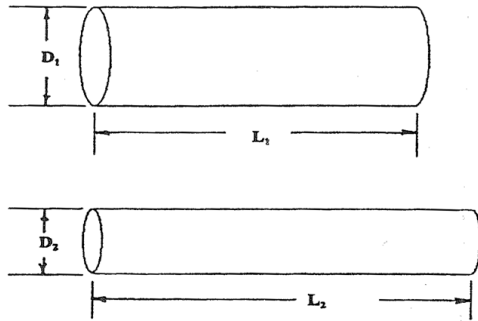

Figure 6. Wire elongation under stress.

If we could somehow bond a piece of fine wire onto a flexure, we could perhaps make use of this change in resistance to measure the change in length of some dimension in a load cell flexure, when a force is applied.

A practical design for such a deflection-sensitive resistance device is shown in Figure 7, magnified 10 times actual size.

The vertical grid lines are the resistance wires, and are aligned with the maximum strain lines in the flexure.

The thicker ends connecting the grid lines at each end are designed to connect the grid lines without introducing resistance which would be sensitive at 90 degrees to the desired sensitive direction. Finally, the large pads are provided for attaching the wires which carry the resistance signal to the external measuring equipment.

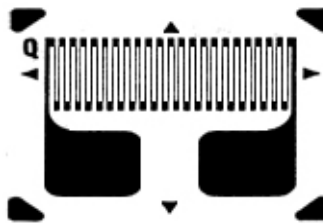

Figure 7. Simple strain gage.

The grid line pattern is created optically on thin Mylar substrate which can then be bonded to the flexure at any location and with the proper orientation to respond to the forces applied to the load cell. This *strain gage* is the heart of the modern load cell, and it has the characteristics which we first outlined as necessary, as follows:

### Thermal Tracking

Since it is bonded to the flexure with a thin glue line of an epoxy, the strain gage tracks the flexure temperature, responding very quickly to any changes.

### Temperature Compensation

An added advantage is the fact that the alloy of the gage can be formulated to provide compensation for the change in *modulus of elasticity* (spring constant) of the flexure with temperature. Thus, the calibration constant of the load cell is more consistent over the *compensated temperature range* (the range of temperatures over which the compensation holds true).

### Creep Compensation

It is also possible to match the creep of the strain gage to the creep of the flexure material, thus at least partially canceling out the creep effect. Interface is able to produce load cells with a creep specification of  $\pm 0.025\%$  of load in 20 minutes, a factor of 10 better than the uncompensated flexure material. On special order, creep performance of  $\pm 0.015\%$  of load has been achieved.

An interesting facet of creep compensation is that, in any production lot, the compensated creep of each load cell can be positive, negative, or even zero. This happens because the gage creep can be slightly smaller than, slightly larger than, or exactly equal to the flexure creep, within the spec limits.

### **Frequency Response**

Since the strain gage's mass is virtually zero, the frequency response of a load cell system is limited only by the response of the flexure itself, the weight of the customer's attached fixtures, and the bandwidth of the external amplifier.

### **Non-Repeatability**

The strain gage is intrinsically repeatable because it is bonded to the flexure and the whole assembly becomes a monolithic structure. The major contributor to non-repeatability of a load cell system is the mechanical connections of the external fixtures.

### **Resolution**

The major advantage of the strain gage as the deflection measuring element is the fact that it has infinite resolution. That means that, no matter how small the deflection, it can be measured as a change in the resistance of the strain gage, limited only by the characteristics of the electronics used to make the measurement. In fact, tests have been run where the load cell output appeared to be erratic simply because the system resolution was too high: someone walked by the lab bench and the force of the moving air caused the reading to shift! Of course, the appropriate resolution should always be used. Too much resolution can sometimes be worse than not enough, especially when the applied loads are erratic themselves, as in many hydraulic systems.

## **Flexure Configurations: Bending Beams**

The field of force measurement has the same types of constraints as any other discipline: weight, size, cost, accuracy, useful life, rated capacity, extraneous forces, test profile, error specs, temperature, altitude, pressure, corrosive chemicals, etc. Flexures are configured in many shapes and sizes to match the diversity of applications out in the world.

### **Bending Beam Cell**

The cell is bolted to a support through the two mounting holes. When we remove the covers, we can see the large hole bored through the beam. This forms thin sections at the top and bottom surface, which concentrate the forces into the area where the gages are mounted on the top and bottom faces

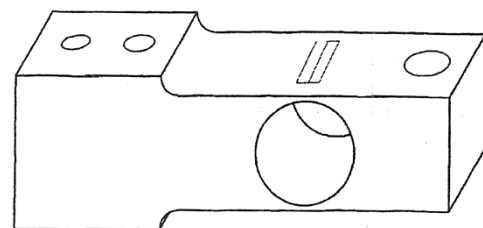

Figure 8. Bending beam flexure.

of the beam. The gages may be mounted on the outside surface, as shown, or inside the large hole.

The compression load is applied at the end opposite from the two mounting holes, usually onto a load button which the user inserts in the loading hole. Interface ME series cells are available in capacities from 5 to 250 lbf. SSB series cells have a splash-proof sealing cover and come in sizes from 50 to 1000 lbf.

### Double-Ended Bending Beam Cell

A very useful variation on the bending beam design is achieved by forming two bending beams into one cell. This allows the loading fixtures to be attached at the threaded holes on the center line, between the beams, which makes the sensitive axis pass through the cell on a single line of action. In general, this configuration is much more user friendly because of its short vertical dimension and compact design.

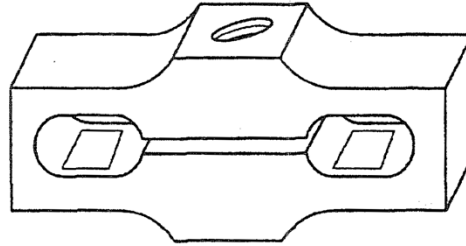

Figure 9. SML double-ended beam.

The Interface SML cell is available in capacities from 5 to 1000 lbf. The 5 and 10 lbf cells can also be ordered with tension/compression overload protection, which makes them very useful for applications where they could be damaged by an overload.

### S-Beam Cells

The Interface SM(Super-Mini) cell is a low-cost, yet accurate, cell with a straight-through loading design. (See Figure 10). At slightly higher cost, the SSM (Sealed Super-Mini) is a rugged S-cell with splash-proof covers. Either series gives exceptional results in applications which can be designed so as to operate the cells in tension.

Although the forces on the gaged area appear the same as in a bending beam cell, the theory of operation is slightly different because the two ends of the “S” bend back over center, and the forces are applied down through the center

of the gaged area. However, considering it as a modified bending beam cell may assist the reader in visualizing how the cell works.

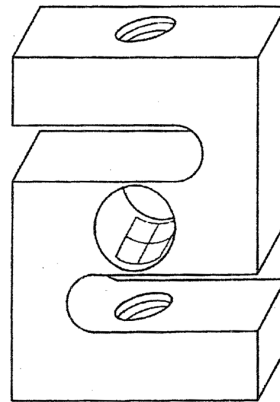

Figure 10. Typical S-beam.

Some caution should be exercised when using these cells in compression, to ensure that the loading does not introduce side loads into the cell. As we shall see later, the Low Profile series is better suited to applications which may apply side loads or moment loads into the cell.

## SMT Overload Protected S-Cell

The incorporation of overload protection is a major innovation in S-Cell design. By removing the large gaps at the top and bottom, and replacing them with small clearance gaps and locking fingers, the whole cell can be made to “go solid” in either *mode* (tension or compression), before the deflection of the gaged area exceeds the allowed overload specification. Those gaps and fingers can be seen in Figure 11, which shows the flexure with the covers removed. The double-stepped shape of the gaps is necessary to ensure that overload protection operates in both modes.

The SMT series is ideally suited for applications that may generate forces as high as eight times the rating of the load cell. The two loading holes are in line vertically, which makes the cell easy to design into machines which apply reciprocating or linear motion, either from a rotating crank or from a pneumatic or hydraulic cylinder.

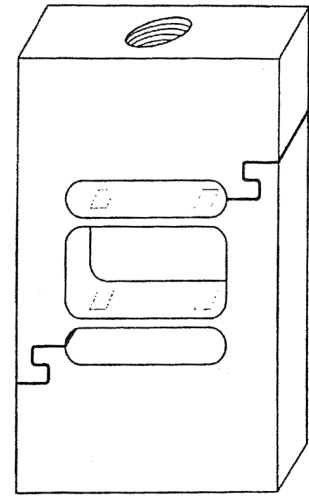

Figure 11. SMT overload-protected flexure.

The covers provide physical protection for the flexure, but the cell is not sealed. Users should therefore be cautioned not to use it in dusty applications which might build up collections of dust in the overload gaps. Should a buildup occur, the overload protection would come into effect before the load reaches the rated capacity, thus causing a non-linear output.

The SMT series is especially suited for use in laboratories or medical facilities where large loads could be applied accidentally by untrained or non-technical personnel.

## LBM and LBT Load Button Cells

Many applications require the measurement of forces in a very confined space. Where high precision is required, the Interface Low Profile cell is the obvious choice. However, where space is at a premium, the smaller LBM or LBT can fulfill the need for force measurements at a very respectable precision, sufficient for most applications.

These miniature compression cells range in capacities from 10 lbf to 50,000 lbf. Diameters range from 1 inch to 3 inches, with heights from 0.39 inch to 1.5 inches. The shaped load button has a spherical radius to help confine misaligned loads to the primary axis of the cell.



Figure 12. LBM load button.



Figure 13. LBS miniature load button.

## SPI Single Point Impact Cell

Although the SPI resembles competitive weigh pan cells, it was specifically designed to have greater than normal deflection at full scale, to provide for the addition of stops to

protect the cell against compression overloads. This was necessary because the usual deflection of 0.001 inch to 0.006 inch of most load cells is much too small to allow for the accurate adjustment of an external stop to protect the load cell.

SPI cells with capacities of 3 lbf, 7.5 lbf, and 15 lbf contain their own internal compression overload stop which is adjusted at the factory to protect the cell up to four times the rated capacity. These cells have an additional bar under the lower surface, to provide a mount for the internal compression stop screw. Capacities of 25 lbf, 50 lbf, 75 lbf, and 150 lbf can be protected by placing hard stops under the corners of a weigh pan to catch the pan before excessive deflection damages the SPI cell.

Figure 14 shows the internal layout typical of the larger capacities of the SPI. The cell mounts to the scale frame on the step at the lower left corner, while the scale pan is mounted on the upper right corner with its load centroid over the *primary axis* at the center of the cell.

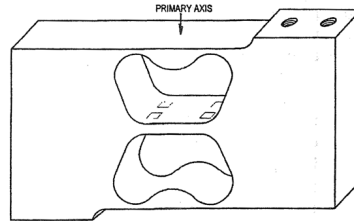

Figure 14. Typical SPI flexure layout.

The center bar, containing the gages, is a bending beam. It is supported by the outer frame containing four thin flexure points, two on the top and two on the bottom, to provide mechanical strength for side loads and moment loads. This construction provides the superior moment canceling capability of the SPI, which ensures a consistent weight indication anywhere within the weigh pan size limits.

The SPI is also very popular with universities and test labs, for its precision and ruggedness. It is also very convenient for lab use. Fixtures and load pans can be mounted easily on the two tapped holes on the top corner.

### 1500 Low Profile Rotated Bending Beam

The Interface Model 1500 combines the moment canceling advantages of the Low Profile design, with the lower capacity desired by many customers who have precision testing applications.

Although the external appearance of the 1500 is quite similar to the 1000 Series cells, the internal construction is quite different. Figure 16 shows the cross section of one of the two crossed beams, and the similarity to the SML double-ended beam is obvious. Moreover, the additional crossed beam, at 90 degrees to the beam shown in section, ensures moment stability in all directions around the primary axis.

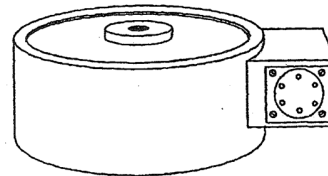

Figure 16. Model 1500 outline.

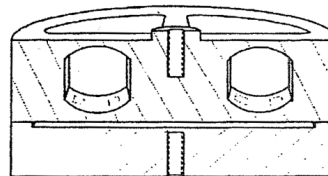

Figure 15. Model 1500 flexure (cross section view).

The Model 1500 is available in capacities from 25 to 300 lbf to complement the Model 1200, whose lowest capacity is 300 lbf. In addition, the diameter of the Model 1500 is



only 2.75 inches, and the connector orientation allows better clearance for the mating connector to clear nearby objects.

Note that the base is integral with the cell, which aligns the whole cell for straight-through applications. The balanced design around the primary axis ensures maximum cancellation of moment forces. The cell is sealed to protect it from the environment in typical production situations.

## Flexure Configurations: Shear Beams

### SSB Shear Beam Cell

From the outside, a shear beam cell might look identical to a bending beam cell, but the theory of operation is entirely different. When the covers are removed we can see that the large hole, instead of passing all the way through the cell, is actually bored part way through from either side, leaving a thin, vertical web in the center of the cell. You can see the gage mounted on that web in Figure 17.

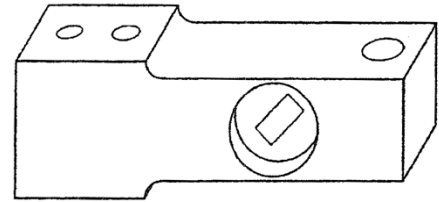

Figure 17. Shear beam flexure.

Notice that the gage is pictured as oriented at 45 degrees to the vertical; this is to remind the reader that the application of a force on the end of the beam causes the web to be stressed in shear, which has a maximum effect at 45 degrees.

The shear beam design is typically used to make larger capacity beam cells because they can be made to be more compact than a bending beam cell of the same capacity. Mounting of either cell is similar; because there is considerable moment loading on the mounting end of the beam, the larger capacities require Grade 8 mounting bolts to provide enough tensile strength to withstand the forces under full load.

### Low Profile Shear Beam Cell

This structure was a dramatic advance in the design of precision load cells, first introduced to the precision measurements community by Interface in 1969. It offered higher output, better fatigue life, better resistance to extraneous loads, a shorter load path, greater stiffness, and the possibility of compression overload protection integral to the cell.

The top view in Figure 18, with the sealing diaphragms removed, shows how the eight holes are bored down through the flexure to leave eight shear webs, formed by the material left between the holes after the boring operation.

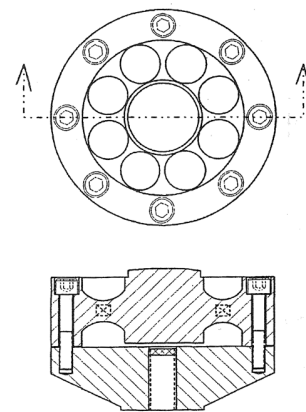

Figure 18. Model 1111 cutaway views.

Referring to the section through the flexure in Figure 18, the reader can visualize how the radial shear webs, along with the center hub and the outside rims on both sides, resemble two shear beam cells end-to-end. The Low Profile cell thus exhibits the stability of a double-ended shear beam, augmented by the fact that the circular design is the equivalent of four double-ended cells, thus providing stability in eight directions about the center point.

The two gages shown in Figure 18 are aligned straight across, rather than at 45 degrees because the gages themselves have their grid lines set at 45 degrees. (See Figure 19.)

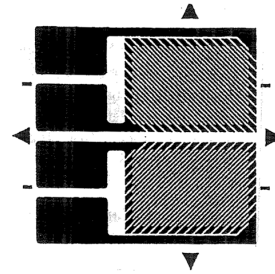

Figure 19. Shear gage.

Figure 18 also shows the base, bolted to the flexure around its outside rim. The base is a flat surface, guaranteed to provide optimum support for the flexure. Use of the base, or a support surface with its equivalent flatness and stability, is required to ensure the exceptional performance of the Low Profile Series. Note that the threaded hole in the base is on center, and a plug is permanently installed to seal dirt and moisture out of the space between the bottom hub of the flexure and the flat surface of the base.

The Low Profile Series comes in both compression models and universal models. The standard configuration for compression cells is shown in Figure 20. The bolts for mounting the cell to the base are socket head cap screws, flush with the top surface, so that the load button protrudes above the top surface of the cell for clearance. The integral load button has a spherical surface, to minimize the effects of misaligned loading on the output. The seven-wire cable version is stocked, because users prefer the extra protection against moisture intrusion into the electrical system. Connector versions are available as a factory option, where the cells will be protected against the environment.

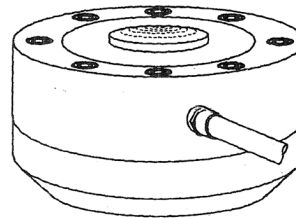

Figure 20. Model 1211-10K.

The standard configuration for universal cells is shown in Figure 21. Hex head machine bolts are used to mount the cell to the base, although socket head cap screws can be provided as a factory option. The electrical connections are brought out to a PC04E-10- 6P connector on stock cells, and several connector styles are also available on special order.

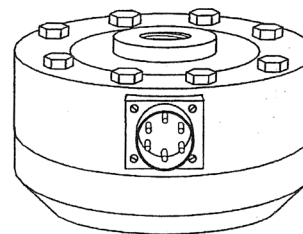

Figure 21. Model 1210-10K.

Compression overload protection is available as an option on both compression cells and universal cells. It provides protection up to 500% of rated capacity on cells up to 25,000 lbf rating, and up to 300% of rated capacity on larger cells. (See our catalog for restrictions on Fatigue Rated cells.) This protection is obtained by limiting the travel of the center hub as it is deflected under load toward the flat surface of the base. (See Figure 18.) By carefully grinding and

lapping the mounting surface of the cell, the gap between the hub and the base is adjusted so that the hub hits the base at about 110% of rated capacity. Any further loading drives the flat hub surface against the base, with very little further deflection. Since this total deflection is of the order of 0.001" to 0.004", this critical adjustment can be done only at the factory, where the cell is mated to the base and tested as a completed assembly.

**NOTE**

This overload protection operates only in compression and is available on both compression and universal cells, except for fatigue rated cells (see below).

The Low Profile Family is available in three major application series: Precision, Ultra Precision, and Fatigue Rated. The smaller cells, from 250 lbf to 10,000 lbf capacity, are in a package 4.12" in diameter and 1.38" thick. Intermediate capacities are contained in packages of 4.75", 6.06", 7.50", 8.00", and 8.25" diameter, from 1.75" to 2.50" thick. The largest universal cell, at 200,000 lbf capacity, is 11" in diameter and 3.5" thick.

The basic construction of all the cells in the family is quite similar. The major differences within each series are in the number of shear beams and the number of gages in the legs of the bridge. The product differentiation between the types relates to the specific application which they are designed to support.

**Extraneous Load Sensitivity**

One process step which is standard in all Low Profile Series cells is adjustment of extraneous load sensitivity. Although the design itself cancels out the bulk of this sensitivity, Interface goes one step further and adjusts each cell to minimize it even more.

Figure 22 shows a simplified view of a moment testing setup. Assuming a weightless arm mounted on a load cell's hub, the load cell's flexure will be stressed by the application of weight "W" on the centerline of the cell. The stress vectors are shown as "W" in the detail in Figure 23.

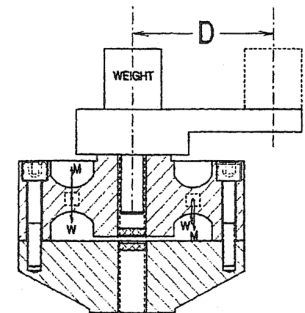

Figure 22. Moment adjustment.

Notice that there is an equal "W" vector on both the right side and the left side of the flexure, because the force of the weight is on the centerline of the cell. The gages are wired into the bridge circuit so as to sum up all the force vectors acting in the same direction in the cells' shear webs, so the weight vectors in this example are additive.

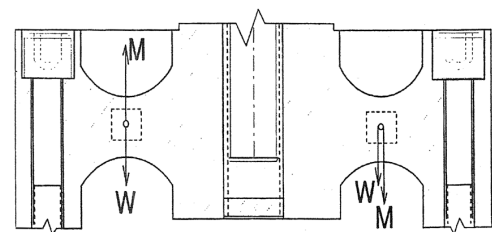

Figure 23. Weight and moment vectors.

If we now move the weight to the end of the arm, “D” distance off the centerline, the cell sees the weight vectors and also a new set of vectors due to the moment “M,” the twisting action caused by the weight’s position at the end of the arm, tending to push down on the web on the right side and pull up on the web on the left side.

Remembering that the gages are connected so as to add the “W” vectors, we can see that the “M” vectors will cancel, thus not causing any output signal due to the moment. This statement will be true, of course, only if both webs are exactly the same dimension and if the two gages have exactly the same gage factor. In practice, everything has a tolerance, so the cancellation of moments probably won’t be within specified limits when the cell is first assembled. In actual practice, the test station is designed so that the arm can be rotated to any position, and each pair of webs is tested and adjusted for optimum cancellation of moments.

### **The Low Profile Precision Series**

This series, with capacities from 300 lbf to 200,000 lbf forms the backbone of the force testing capability at companies all over the world. It features very competitive prices combined with specifications which satisfy the majority of force testing applications. It offers 4 mV/V output in 5,000 lbf and greater capacities, resistance to extraneous loads, a short load path, very low compliance (high stiffness), and a very respectable static error band specification ( $\pm 0.04\%$  to  $0.07\%$  FS).

### **The Low Profile Ultra Precision Series**

This series, with capacities from 300 lbf to 200,000 lbf, was developed to satisfy the most demanding requirements of sophisticated testing labs. It features a very moderate price adder over the Precision Series, combined with specifications which are better than the Precision Series cells in the critical parameters, such as static error band ( $\pm 0.02\%$  to  $0.06\%$  FS), non-linearity, hysteresis, non-repeatability, and extraneous load sensitivity.

### **The Low Profile Fatigue Rated Series**

This series, with capacities from 250 lbf to 100,000 lbf, is the industry standard in the world of aerospace fatigue testing. It features a guaranteed fatigue life of 100 million fully reversed load cycles. Although constructed in the same packages as the Precision Series, the Fatigue Rated Series has tighter specifications on resistance to extraneous loads and it offers stiffer compliance, for example, 33,000,000 lb/inch in the 100,000 lbf capacity. Since fatigue testing generally involves applying bimodal forces to test samples through the load cell, compression-only cells are not available in this series. Also, because of the cells’ very low deflections, overload protection is not available.

Most people generally have an idea about the meaning of the word “fatigue,” as it relates to the failure of a truck spring, for example. They envision the part, after thousands of hours of operation under vibration and shock loads, finally just “giving up” and failing. However, the phrase “fatigue rated,” as it applies to an Interface load cell, has a much more explicit and well defined meaning.

### **FATIGUE RATED LOAD CELL**

An Interface Fatigue Rated load cell will still meet its performance specifications after being subjected to 100 million fully reversed load cycles. Also, its static overload rating is 300% in both modes, tension and compression.

The fatigue rated design was developed to support the critical testing requirements in the aircraft and space programs. Not only was it necessary to have a load cell which would survive while driving the life test of critical aircraft and missile parts, but it was also crucial that the load cell still meet the specifications during the whole test, to avoid having to repeat expensive tests due to failure of a load cell.

Another advantage of the Low Profile design was the ability to install two, sometimes three, or in some cases four electrically isolated bridges in one load cell package. Many customers used this feature to provide a backup recording of the whole test, from the "B" bridge, to verify the test in the event of a failure in the primary data chain from "A" bridge of the load cell. The "B" bridge thus is able to back up the test system for either a failure of Bridge "A" in the load cell itself or for the failure of any element in the data/recording channel for Bridge "A."

A more technically complete explanation of fatigue as it applies to load cell flexure design is published in the Interface catalog and on the Interface Web site.

### **Compression Loading**

The application of compression loads on a load cell requires an understanding of the distribution of forces between surfaces of various shapes and finishes.

The first, and most important, rule is this: Always avoid applying a compression load flat-to-flat from a plate to the top surface of a load cell hub. The reason for this is simple: it is impossible to maintain two surfaces parallel enough to guarantee that the force will end up being centered on the primary axis of the load cell. Any slight misalignment, even a few micro inches, could move the contact point off to one edge of the hub, thus inducing a large moment into the measurement.

One common way to load in compression mode is to use a load button. Most compression cells have an integral load button, and a load button can be installed in any universal cell to allow compression loading. Minor misalignments merely shift the contact point slightly off the centerline. Figure 25 shows a major misalignment, and even the five degrees shown would shift the contact point only 3/8" off center on a load button having a 4" spherical radius, which is the type normally used on load cells up to 10,000 lbf capacity. For 50,000 lbf loading, a 6" radius is used, and for 200,000 lbf loading a 12" radius is used.

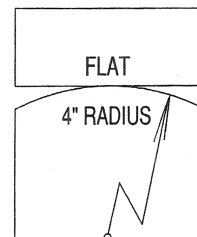

Figure 24. Load button and plate.

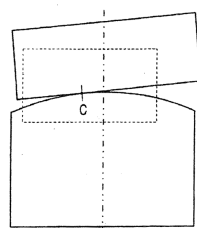

Figure 25. Five degree misalignment.

In addition to compensating for misalignment, the use of a load button of the correct spherical radius is absolutely necessary to confine the stresses at the contact point within the limits of the materials. Generally, load buttons and bearing plates are made from hardened tool steel, and the contacting surfaces are ground to a finish of 32  $\mu$ inch RMS.

Use of too small a radius will cause failure of the material at the contact point, and a rough finish will result in galling and wear of the loading surfaces. The half sections in Figure 26 show (in exaggerated form) the indentation radius ( $R_1$ ) on a flat plate caused by a load button having a 4 inch spherical radius; and the corresponding indentation ( $D_1$ ). The strains transmitted into the flat plate by a 10,000 lbf load are well within the specs for hardened steel. Compare that with the indentation radius ( $R_2$ ) and the corresponding indentation ( $D_2$ ). In this case, the strains could actually cause the steel to fracture.

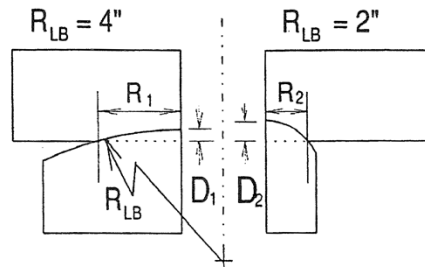

Figure 26. Indentation of correct load button spherical radius versus smaller radius.

Any one of the cells seen so far can be used in compression by mounting a load button in the cell and providing a smooth, hardened steel plate to apply the load to the cell. The disadvantage of this application is that, although the load will be supported properly for weighing, it will not be constrained from moving horizontally. The usual solution for this problem is to provide check rods which are strategically placed to tie the load to the support framework. Of course, it is essential these rods be exactly horizontal; otherwise, they will induce forces into the weighing system which don't reflect the true loading.

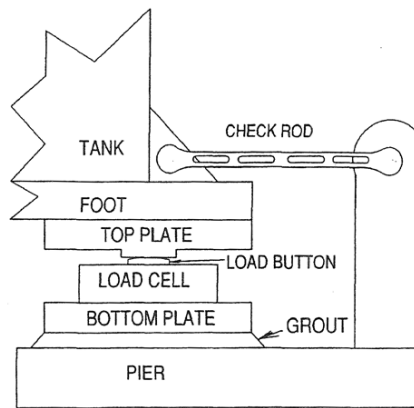

Figure 27. Typical compression foot and check rod installation.

## WeighCheck™ Weighing System

The complex mountings and check rods in a compression weigh system can be replaced in most cases with the simple, innovative self-storing and self-checking system developed in Figure 28 and pictured in Figure 29.

Note that, as the rocker rotates, the top plate rises. Thus, the weight of the load will tend to return the rocker to its original position. The spherical radius of the "football" can be very large, but it can be made much shorter than the equivalent round ball. The reader could imagine making a rocker by slicing a thick

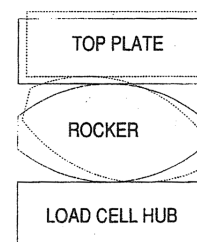

Figure 28. "Football" self-centering system.

horizontal section out of a round ball and then gluing the remaining two pieces together.

In Figure 29, the rocker is modified even more drastically to remove all the unnecessary material. The only spherical surfaces that remain are at the top and bottom, to make contact with the top plate and the loading surface inside the load cell. The sealing boot is made of

molded rubber, to keep dirt and water away from the lower surface of the rocker. The boot is held down against the hub of the load cell by a lip on the rocker.

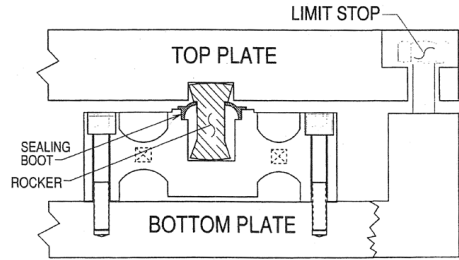

Figure 29. WeighCheck weigh mount.

There are two limit stops, one at each end of the top plate, formed by oversize clearance holes in the top plate and shoulder bolts which are screwed firmly into each end of the bottom plate. These limits operate both horizontally and vertically to contain the system in all directions.

The unique rocker provides a weigh mount with an extremely low profile, only 4" tall in the low capacities (5,000 and 10,000 lbf) and 5" tall in the high capacities (25,000 and 50,000 lbf). It is available in a tool steel version or a stainless steel version.

### LoadTrol™ Oil Well Pump-Off Control Cell

All of the cells in the Interface product lines are either beam cells, S-cells, or shear beam cells, except for this single exception, the LoadTrol, a pipe column cell.

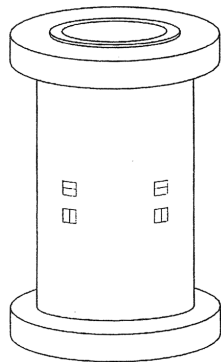

Figure 30. LoadTrol flexure spool.

Interface would not normally make a column cell as a standard product, for reasons which will be shown in the next section. However, the pipe design was particularly suited to this application, which required the cell to measure the

tension in the polish rod, the rod which goes all the way down to the bottom of an oil well, to drive the pump which raises the oil to the surface.

The polish rod must carry the weight of its whole length, plus the pumping forces, plus

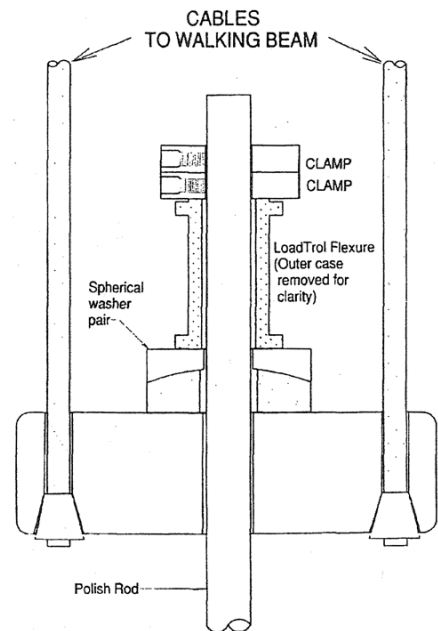

Figure 31. Oil well pumping application.

the weight of the column of oil in its way to the surface. The two spool flexure designs which Interface provides are rated at 30,000 lbf and 50,000 lbf. They both have an overload rating of twice the rated capacity, necessary because certain pumping conditions can cause serious thumping loads on the system, thus imposing high impact loads on the flexure.

Although it has been used in other applications, the spool flexure was designed specifically for controlling oil well pumps, as shown in Figure 31. We are all familiar with the “rocking horse” pumps (formally called “pump jacks”) which dot the countryside all over the United States. The two cables pull up on the crossbar, which drives up through the spherical washers, through the load cell, which drives the polish rod through the clamps at the top of the rod. The spherical washers take out any misalignments which might otherwise introduce moments into the load cell.

The system is relatively simple and foolproof. However, since it used outside, it is subject not only to the weather, but also to the nemesis of all electronics systems: lightning. Therefore MOVs (Metal Oxide Varistors) are included inside the casing of the LoadTrol to short any excessive voltage directly to the case ground, to protect the gages. (See Figure 32.)

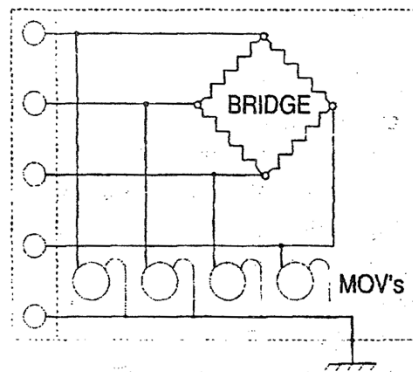

Figure 32. LoadTrol MOVs.

## Competitive Load Cell Product Configurations

### The Simple Column Cell

All Interface, Inc. products are designed around either the bending beam, the shear beam, or the pipe column. In order to understand the reasons behind this decision, we need to understand the design of the plain column cell, the other major type of load cell.

The cross-section view in Figure 33 shows the components of the simple column cell. The “flexure” is the heavy column (A) running up the center of the cell, with massive blocks at the top and bottom and a thin, usually square, column in the center. This column, plus the heavy outer shell and the diaphragms (B) are the basic support elements for the measurement flexure, the column (A) which runs from  $S_1$  to  $S_2$ .

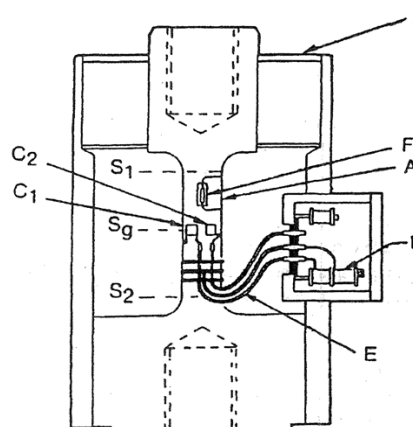

Figure 33. Simple column cell.



The column stress between  $S_1$  and  $S_2$  is about the same anywhere along its length, so the main gages ( $C_1$  and  $C_2$ ) are placed in the center, at  $S_g$ . Compensation for the nonlinearity of the column design is accomplished by the semiconductor gage (F).

Loads are applied by the customer's fixtures which can be screwed into the threaded holes at the top and bottom ends of the column.

The "doghouse" on the side of the casing contains the bridge compensating resistors (D) which are wired (E) to the gages.

At first glance, this might seem to be an uncomplicated design. The physical parts themselves are relatively simple to produce. However, several characteristics seriously restrict its usability.

- The thermal path from the column (A) to the outer case is very long and has a thin cross section, thus causing the temperature gradients to take a long time to stabilize. If heat is applied to one side of the case, the case itself will expand on the hot side, and a moment will be applied to the column, causing a zero shift.
- If heat is applied to the doghouse side of the cell, the compensating resistors will change resistance before the column sees the temperature change. Thus, the resistors will be attempting to compensate for a change which has not even occurred yet, causing a zero shift and an output shift.
- The diaphragms are an important part of the support, to keep moment loads away from the column. However, since they are outside of the gaged areas of the column, they are a non-gaged parallel path which introduces their errors (nonlinearity, hysteresis, and thermal response) directly into the measurement path. The diaphragms cannot be strong enough to protect the column from pure moment loads, without introducing significant errors.
- Changes in pressure due to barometric change or altitude testing act on the diaphragm, causing a zero shift. For example, a six inch diameter diaphragm would induce a force change of 375 pounds into a column cell in a test from sea level to space orbit altitude.
- The cell is quite tall, making it more difficult to integrate into compact testing equipment.
- Since the cross sectional area of the column changes with loading and is different between tension and compression modes, the output is non-linear and unsymmetrical. Non-linear semiconductor gages can be used to compensate the non-linearity, but only in one mode.

### **Advantages of the LowProfile Cell**

By contrast, the LowProfile cell compares dramatically better in all respects to the simple column cell.

- The thermal path is massive and surrounds the whole cell. The thermal path between the outside surface and all the gages is very short. Temperature gradients are almost non-existent, and they settle out very quickly.

- Compensating resistors are mounted on the flexure, in close proximity to the gages.
- The diaphragms are used only as a sealing mechanism, not as a support, so they do not introduce appreciable errors into the cell.
- There are two opposing diaphragms, one on the top and one on the bottom of the cell. Their opposing forces due to pressure are equal and opposite, thus canceling out pressure effects.
- The cell is short and squat, thus making it much easier to integrate into system designs. Column cells range in height from 6" to 24", compared to a Low Profile cell's height with base, of 2.5" to 6.5".
- The design is intrinsically moment canceling and is rotationally symmetrical. In addition, moment cancellation is enhanced by special testing and adjustment in the factory.
- Since the cross sectional area of the flexure does not change appreciably with loading, the output is intrinsically more linear and is also symmetrical between tension and compression modes.
- The output of the shear beam cell is up to 2.5 times the output of a column cell at the same stress level in the flexure.
- The overall Low Profile design is more compact, with all the components bonded to the flexure structure, thus making it better able to withstand the 100 million cycle fatigue life.

## Input/Output Characteristics and Errors

### Gage Interconnection Configurations

Strain gages have been used for many decades for measuring the stresses in mechanical components of aircraft and other active and passive structures.

Sometimes, one simple gage can give the necessary information, and in those instances where hundreds or even thousands of gages are needed to implement a large test, use of the quarter bridge configuration of Figure 34 is a cost control necessity. The only active bridge leg (a strain gage) is shown as (AC), and the other three inactive legs (A'B', B'D' and C'D') are fixed resistors, to simulate a complete bridge.

In certain cases, it is even possible to use the quarter bridge in a load cell, where temperature compensation and moment compensation are not a necessity, as in a cheap bathroom scale.

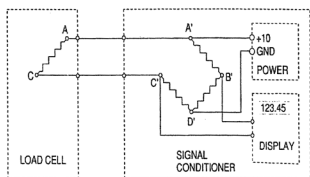

Figure 36. Quarter bridge connection.

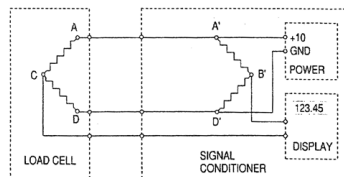

Figure 35. Half bridge connection.

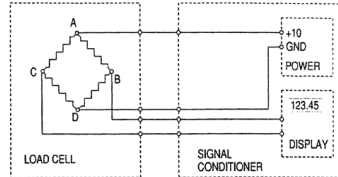

Figure 34. Full bridge connection.

The half bridge connection is usually used for low cost load cells which are designed for specific OEM applications, where the customer can adapt a special design to make use of the cell's unique parameters.

The full bridge is the only one which has enough active legs to allow for easy compensation for temperature coefficients of both zero and span and to allow adjustment of moment sensitivity.

Other parameters being equal, a full bridge has twice the output of a half bridge and four times the output of a quarter bridge.

### Temperature Effect on Zero and Output

Interface proprietary gages are designed specifically to compensate the temperature effect on the modulus of elasticity of the flexure material, thus providing essentially a constant output over the compensated temperature range. The specification for each load cell series states the coefficient, typically  $\pm 0.08\%$  per 100 degrees F.

A small zero balance shift, due to the differences between the temperature coefficient of resistance of the gages, must be tested and adjusted at the factory.

The usual method in the load cell industry uses only two temperatures, ambient room and 135°F. The best result which can be obtained by this method is shown in Figure 37 as the "room-high compensated" curve.

At Interface, the test is run at both low and high temperature. This method is more costly and time consuming, but it results in the "c-h compensated" curve, which has two distinct advantages.

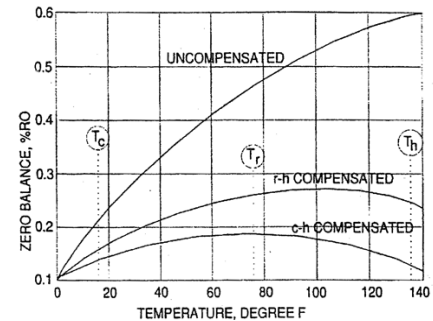

Figure 37. Temperature compensation, zero balance.

- The curve's maximum occurs near room temperature. Thus, the slope is almost flat over the most-used temperatures near room ambient.
- The overall variation over the compensated temperature range is much less.

The graphs of Figures 38 and 39 show, separately, the effect of temperature on zero balance and output, so it is easier for the reader to visualize what happens to the signal

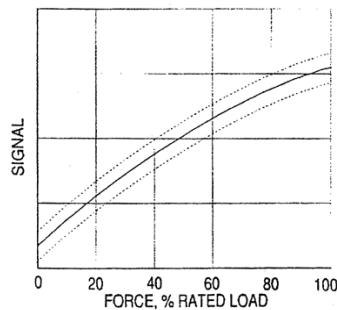

Figure 39. Temperature effect on zero.

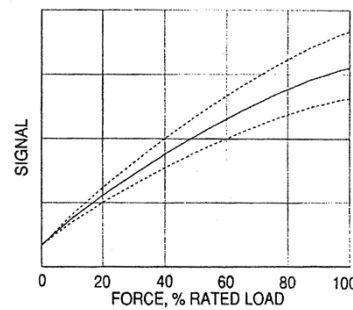

Figure 38. Temperature effect on output.

output curve of the load cell as the temperature is varied. Notice that zero shift moves the whole curve parallel to itself: while output shift tips the slope of the output curve.

## Load Cell Electrical Output Errors

When a load cell is first calibrated, it is exercised three times to at least its rated capacity, to erase all history of previous temperature cycles and mechanical stresses. Then, loads are applied at several points from zero to rated capacity. The typical production test for a Low Profile cell consists of five ascending points and one descending point, called the “hysteresis point” because *hysteresis* is determined by noting the difference between the outputs at the ascending point and corresponding descending point, as shown in Figure 40. Hysteresis is usually tested at 40 to 50 percent of *full scale*, the maximum load in the test cycle.

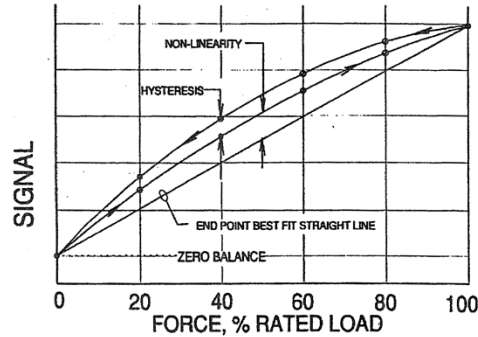

Figure 40. Simplified error graph.

There are many definitions of “best fit straight line,” depending on the reason that a linear representation of the output curve is needed. The *end point line* is necessary in order to determine *non-linearity*, the worst case deviation of the output curve from the straight line connecting the zero load and rated load output points. (See Figure 40.)

A more sophisticated and useful straight line is the *SEB Output Line*, a zero-based line whose slope is used to determine the *Static Error Band* (SEB). As shown in Figure 41, the static error band contains all the points, both ascending and descending, in the test cycle. The upper and lower limits of the SEB are two parallel lines at an equal distance above and below the SEB Output Line.

### NOTE

The reader should keep in mind that the non-linearity, hysteresis and nonreturn to zero errors are grossly exaggerated in the graphs to demonstrate them visually. In reality, they are about the width of the graph lines.

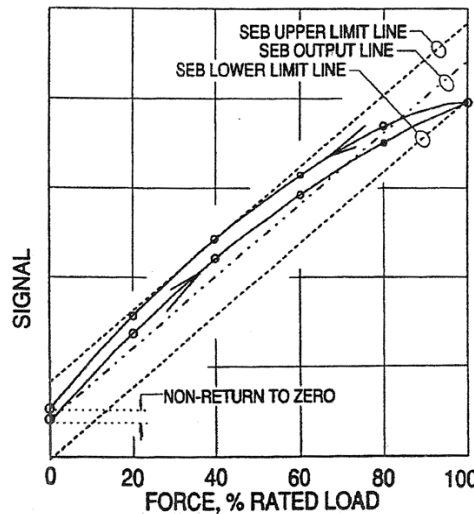

Figure 41. Static error band.

## Resistance to Extraneous Loads

All load cells have a measurable response when loaded on the primary axis. They also have a predictable response when a load is applied at an angle from the primary axis. (See Figures 42 and 43.) The curve represents the equation:

$$\text{Relative Off-Axis Output} = (\text{On-Axis-Output}) \times (\cos \theta)$$

For very small angles, such as the misalignment of a fixture, the cosine can be looked up in a table and will be found to be quite close to 1.00000. For example, the

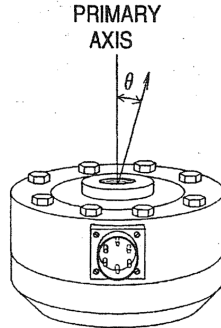

Figure 42. Off-axis loading.

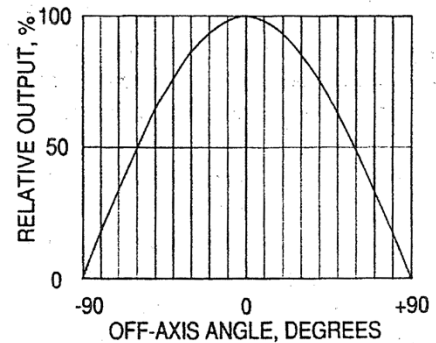

Figure 43. Relative output versus angle.

cosine of 1/2 degree is 0.99996, which

means the error would be 0.004%. For 1 degree, the error would be 0.015%, and for 2 degrees, the error would be 0.061%. In many applications, this level of error is quite livable. For large angles, it would be advisable to calculate the moment induced in the cell, to ensure that an overload condition will not occur.

Because of the close tolerance machining of flexures, the matching of gages; and precision assembly methods, all Interface load cells are relatively insensitive to the extraneous loads shown in Figure 44: moments ( $M_x$  and  $M_y$ ), torques ( $T$ ), and side loads ( $S$ ). In addition, the resistance to extraneous loads of the Low Profile Series is augmented by an additional step in the manufacturing process which adjusts the moment sensitivity to a tighter specification.

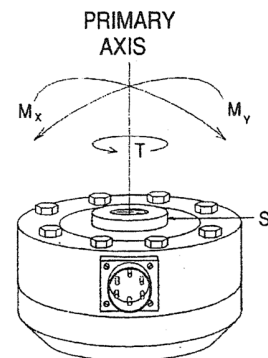

Figure 44. Extraneous load vectors.

### CAUTION

Take care not to exceed the torque allowances in the specifications. The torque figures for attaching fixtures to a load cell are much less than the Mechanics Handbook values for the same sized threads.

## System Errors

Customers frequently ask, “What are the resolution, repeatability, and reproducibility of Interface load cells?” The answer is, “Those are system parameters, not load cell parameters, which depend on (1) the proper application of the load cell, (2) the forcing systems and mechanical fixtures used to apply the loads, and (3) the electrical equipment used to measure the load cell output.”

Load cell resolution is essentially infinite. That is to say, if the user is willing to spend enough money to build a temperature-stable, force-free environment and to provide extremely stable, high gain electronics, the load cell can measure extremely small increments of force. The most difficult problems to solve are temperature variations from heating/cooling systems, forces such as air motion and building vibration, and the inability of hydraulic forcing systems to maintain a stable pressure over time. It is very common for users to demand, pay for, and get too much resolution in the measuring equipment. The result is outputs which are difficult to read, because the display digits are continually rolling due to instabilities in the overall system.

Non-repeatability is frequently blamed on the load cell, until the user takes the trouble to analyze and track down all the causes of so-called “erratic” readings. Under optimum mechanical and electrical conditions, repeatability of the load cell itself can be demonstrated to be at the same order of magnitude as resolution, far better than necessary in any practical force measurement system.

Repeatability is affected by any one of the following factors:

- Tightness of the mechanical connection of fixtures
- Rigidity of the load frame or force application system
- Repeatability of the hydraulic forcing system itself
- Application of a dead weight load too quickly, causing over-application of the force due to impact
- Poor control of reading times, introducing creep into the data
- Unstable electronics due to temperature drift, power line susceptibility, noise, etc.

**Reproducibility** is the ability to take measurements on one test setup and then repeat them on different test setup. The two setups are defined as different if one or more element in the setup is changed. Therefore, inability to repeat a set of measurements could be found in one facility where only one fixture was changed. Or, a discrepancy could be uncovered between two test facilities, which could become a major problem until the differences between the two are analyzed and corrected.

Reproducibility is a term not heard very often, but it is the very essence of the calibration process, where a cell is calibrated at one location and then used to measure forces at another location.

Reproducibility is achieved most easily by using Interface Gold Standard® load cells. The low moment sensitivity makes them less susceptible to misalignments in load frames. That, combined with the permanently installed loading stud, high output, and low creep, make them the cell of choice with users who cannot compromise – who need the very best.

# GENERAL PROCEDURES FOR THE USE OF LOAD CELLS

## Excitation Voltage

Interface load cells all contain a full bridge circuit, which is shown in simplified form in Figure 1. Each leg is usually 350 ohms, except for the model series 1500 and 1923 which have 700 ohm legs.

The preferred excitation voltage is 10 VDC, which guarantees the user the closest match to the original calibration performed at Interface. This is because the gage factor (sensitivity of the gages) is affected by

temperature. Since heat dissipation in the gages is coupled to the flexure through a thin epoxy glue line, the gages are kept at a temperature very close to the ambient flexure temperature. However, the higher the power dissipation in the gages, the farther the gage temperature departs from the flexure temperature. Referring to Figure 2, notice that a 350 ohm bridge dissipates 286 mw at 10 VDC. Doubling the voltage to 20 VDC quadruples the dissipation to 1143 mw, which is a large amount of power in the small gages and thus causes a substantial increase in the temperature gradient from the gages to the flexure. Conversely, halving the voltage to 5 VDC lowers the dissipation to 71 mw, which is not significantly less than 286 mw.

Operating a Low Profile cell at 20 VDC would decrease its sensitivity by about 0.07% from the Interface calibration, whereas operating it at 5 VDC would increase its sensitivity by less than 0.02%. Operating a cell at 5 or even 2.5 VDC in order to conserve power in portable equipment is a very common practice.

Certain portable data loggers electrically switch the excitation on for a very low

proportion of the time to conserve power even further. If the duty cycle (percentage of “on” time) is only 5%, with 5 VDC excitation, the heating effect is a miniscule 3.6 mw, which could cause an increase in sensitivity of up to 0.023% from the Interface calibration.

Users having electronics which provide only AC excitation should set it to 10 VRMS, which would cause the same heat dissipation in the bridge gages as 10 VDC.

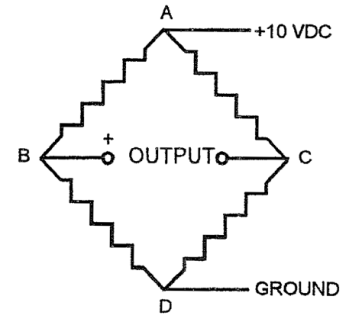

Figure 1. Full bridge circuit.

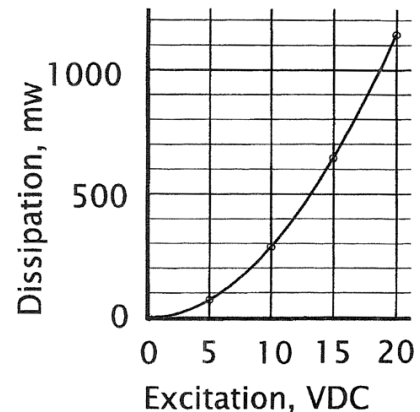

Figure 2. Dissipation versus excitation voltage (350 ohm bridge).

Variation in excitation voltage can also cause a small shift in zero balance and creep. This effect is most noticeable when the excitation voltage is first turned on. The obvious solution for this effect is to allow the load cell to stabilize by operating it with 10 VDC excitation for the time required for the gage temperatures to reach equilibrium. For critical calibrations this may require up to 30 minutes.

Since the excitation voltage is usually well regulated to reduce measurement errors, the effects of excitation voltage variation are typically not seen by users except when the voltage is first applied to the cell.

## Remote Sensing of Excitation Voltage

Many applications can make use of the four-wire connection shown in Figure 3. The signal conditioner generates a regulated excitation voltage,  $V_x$ , which is usually 10 VDC. The two wires carrying the excitation voltage to the load cell each have a line resistance,  $R_w$ . If the connecting cable is short enough, the drop in excitation voltage in the lines, caused by current flowing through  $R_w$ , will not be a problem.

Figure 4 shows the solution for the line drop problem. By bringing two extra wires back from the load cell, we can connect the voltage right at the terminals of the load cell to the sensing circuits in the signal conditioner. Thus, the regulator circuit can maintain the excitation voltage at the load cell precisely at 10 VDC under all conditions.

This six-wire circuit not only corrects for the drop in the wires, but also corrects for changes in wire resistance due to temperature. Figure 5 shows the magnitude of the errors generated by the use of the four-wire cable, for three common sizes of cables.

The graph can be interpolated for other wire sizes by noting that each step increase in wire size increases resistance (and thus line drop) by a factor of 1.26 times. The graph can also be used to calculate the error for different cable lengths by calculating the ratio of the length to 100 feet, and multiplying that ratio times the value from the graph.

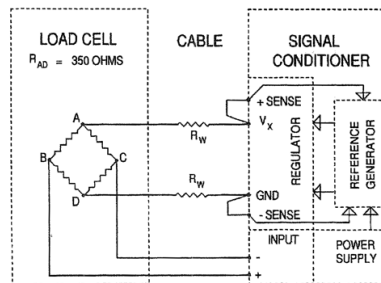

Figure 3. Four-wire connection.

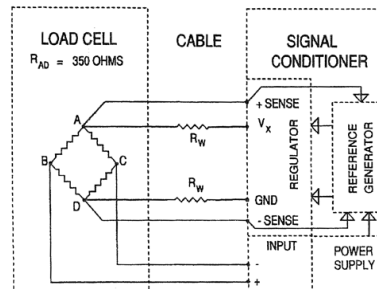

Figure 4. Six-wire remote sense connection.

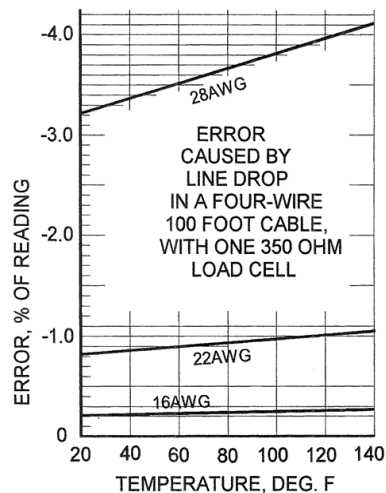

Figure 5. Line drop versus temperature for common cable sizes.



The temperature range of the graph may seem broader than necessary, and that is true for most applications. However, consider a #28AWG cable which runs mostly outside to a weigh station in winter, at 20 degrees F. When the sun shines on the cable in summer, the cable temperature could rise to over 140 degrees F. The error would rise from -3.2% RDG to -4.2% RDG, a shift of -1.0% RDG.

If the load on the cable is increased from one load cell to four load cells, the drops would be four times worse. Thus, for example, a 100-foot #22AWG cable would have an error at 80 degrees F of  $(4 \times 0.938) = 3.752\%$  RDG.

These errors are so substantial that standard practice for all multiple-cell installations is to use a signal conditioner having remote sense capability, and to use a six-wire cable out to the junction box which interconnects the four cells. Keeping in mind that a large truck scale could have as many as 16 load cells, it is critical to address the issue of cable resistance for every installation.

Simple rules of thumb which are easy to remember:

1. The resistance of 100 feet of #22AWG cable (both wires in the loop) is 3.24 ohms at 70 degrees F.
2. Each three steps in wire size doubles the resistance, or one step increases the resistance by a factor of 1.26 times.
3. The temperature coefficient of resistance of annealed copper wire is 23% per 100 degrees F.

From these constants it is possible to calculate the loop resistance for any combination of wire size, cable length, and temperature.

## Physical Mounting: “Dead” and “Live” End

Although a load cell will function no matter how it is oriented and whether it is operated in tension mode or compression mode, mounting the cell properly is very important to ensure that the cell will give the most stable readings of which it is capable.

All load cells have a “dead” end and a “live” end. The dead end is defined as the mounting end which is directly connected to the output cable or connector by solid metal, as shown by the heavy arrow in Figure 6.

Conversely, the live end is separated from the output cable or connector by the gage area of the flexure.

This concept is significant, because mounting a cell on its live end makes it subject to forces introduced by moving or pulling the cable, whereas mounting it on the dead end ensures that the forces coming in through the cable are shunted to the mounting instead of being measured by the load cell.

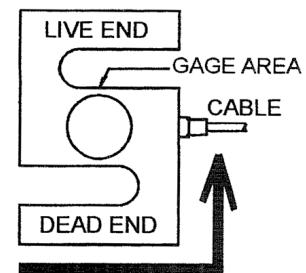

Figure 6. Loading ends of S-cell.

Generally, the Interface nameplate reads correctly when the cell is sitting on the dead end on a horizontal surface. Therefore, the user can use the nameplate lettering to specify the required orientation very explicitly to the installation team. As an example, for a single cell installation holding a vessel in tension from a ceiling joist, the user would specify mounting the cell so that the nameplate reads upside down. For a cell mounted on a hydraulic cylinder, the nameplate would read correctly when viewed from the hydraulic cylinder end.

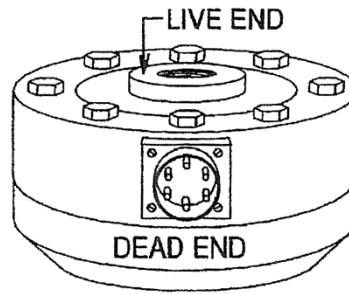

Figure 7. Loading ends of Low Profile cell.

#### **NOTE**

Certain Interface customers have specified that their nameplate be oriented upside down from normal practice. Use caution at a customer's installation until you are certain that you know the nameplate orientation situation.

## **Mounting Procedures for Beam Cells**

Beam cells are mounted by machine screws or bolts through the two untapped holes at the dead end of the flexure. If possible, a flat washer should be used under the screw head to avoid scoring the surface of the load cell. All bolts should be Grade 5 up to #8 size, and Grade 8 for 1/4" or larger. Since all of the torques and forces are applied at the dead end of the cell, there is little risk that the cell will be damaged by the mounting process. However, avoid electric arc welding when the cell is installed, and avoid dropping the cell or hitting the live end of the cell. For mounting the cells:

- MB Series cells use 8-32 machine screws, torqued to 30 inch-pounds
- SSB Series cells also use 8-32 machine screws through 250 lbf capacity
- For the SSB-500 use 1/4 - 28 bolts and torque to 60 inch-pounds (5 ft-lb)
- For the SSB-1000 use 3/8 - 24 bolts and torque to 240 inch-pounds (20 ft-lb)

## **Mounting Procedures for Other Mini Cells**

In contrast to the rather simple mounting procedure for beam cells, the other Mini Cells (SM, SSM, SMT, SPI, and SML Series) pose the risk of damage by applying any torque from the live end to the dead end, through the gaged area. Remember that the nameplate covers the gaged area, so the load cell looks like a solid piece of metal. For this reason, it is essential that installers are trained in the construction of Mini Cells so that they understand what the application of torque can do to the thin gaged area in the center, under the nameplate.

Any time that torque must be applied to the cell, for mounting the cell itself or for installing a fixture onto the cell, the affected end should be held by an open end wrench or a Crescent wrench so that the torque on the cell can be reacted at the same

end where the torque is being applied. It is usually good practice to install fixtures first, using a bench vise to hold the load cell's live end, and then to mount the load cell on its dead end. This sequence minimizes the possibility that torque will be applied through the load cell.

Since the Mini Cells have female threaded holes at both ends for attachment, all threaded rods or screws must be inserted at least one diameter into the threaded hole, to ensure a strong attachment. In addition, all threaded fixtures should be firmly locked in place with a jam nut or torqued down to a shoulder, to ensure firm thread contact. Loose thread contact will ultimately cause wear on the load cell's threads, with the result that the cell will fail to meet specifications after long-time use.

Threaded rod used to connect to Mini Series load cells larger than 500 lbf capacity should be heat treated to Grade 5 or better. One good way to get hardened threaded rod with rolled Class 3 threads is to use Allen drive set screws, which can be obtained from any of the large catalog warehouses like McMaster-Carr or Grainger.

For consistent results, hardware like rod end bearings and clevises can be installed at the factory by specifying the exact hardware, the rotation orientation, and the hole-to-hole spacing on the purchase order. The factory is always pleased to quote the recommended and possible dimensions for attached hardware.

## Mounting Procedures for Low Profile Cells With Bases

When a Low Profile cell is procured from the factory with the base installed, the mounting bolts around the periphery of the cell have been properly torqued and the cell has been calibrated with the base in place. The circular step on the bottom surface of the base is designed to direct the forces properly through the base and into the load cell. The base should be bolted securely to a hard, flat surface.

If the base is to be mounted onto the male thread on a hydraulic cylinder, the base can be held from rotating by using a spanner wrench. There are four spanner holes around the periphery of the base for this purpose.

With regard to making the connection to the hub threads, there are three requirements which will ensure achieving the best results.

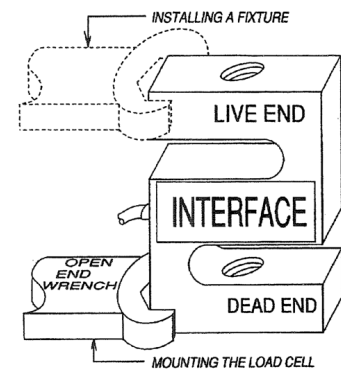

Figure 8. Reacting mounting and installation torques.

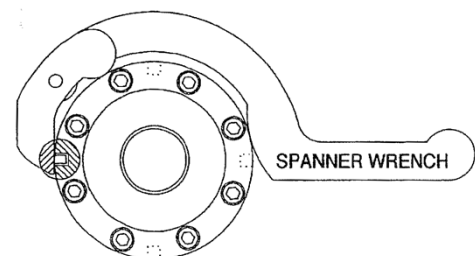

Figure 9. Using a spanner wrench to hold base from rotating.

1. The part of the threaded rod which engages the load cell's hub threads should have Class 3 threads, to provide the most consistent thread-to-thread contact forces.
2. The rod should be screwed into the hub to the bottom plug, and then backed off one turn, to reproduce the thread engagement used during the original calibration.
3. The threads must be engaged tightly by the use of a jam nut. The easiest way to accomplish this is to pull tension of 130 to 140 percent of capacity on the cell, and then lightly set the jam nut. When the tension is released, the threads will be properly engaged. This method provides more consistent engagement than attempting to jam the threads by torquing the jam nut with no tension on the rod.

In the event the customer does not have the facilities for pulling enough tension to set the hub threads, a Calibration Adapter can also be installed in any Low Profile cell at the factory. This configuration will yield the best possible results, and will provide a male thread connection which is not so critical as to the method of connection.

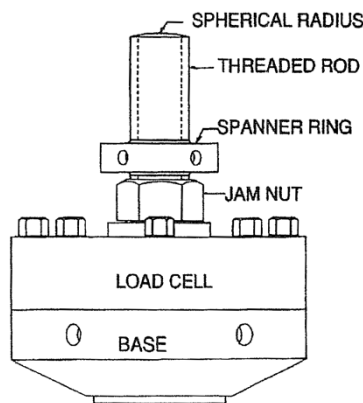

Figure 10. Load cell with calibration adapter installed.

In addition, the end of the Calibration Adapter is formed into a spherical radius which also allows the cell to be used as a straight compression cell. This configuration for compression mode is more linear and repeatable than the use of a load button in a universal cell, because the calibration adaptor can be installed under tension and jammed properly for more consistent thread engagement in the cell.

## Mounting Procedures for Low Profile Cells Without Bases

The mounting of a Low Profile cell should reproduce the mounting that was used during the calibration. Therefore, when it is necessary to mount a load cell on a customer-supplied surface, the following five criteria should be strictly observed.

1. The mounting surface should be of a material having the same coefficient of thermal expansion as the load cell, and of similar hardness. For cells up through 2000 lbf capacity, use 2024 aluminum. For all larger cells, use 4041 steel, hardened to Rc 33 to 37.
2. The thickness should be at least as thick as the factory base normally used with the load cell. This does not mean that the cell will not

Model	Torque (ft-lb)	Torque (N-m)
1210	5	7
1211	5	7
1220	45	60
1221	25	35
1231	80	105
1232	120	160
1240	250	350
1241	250	350
3210	5	7
3211	5	7
3220	45	60
3221	25	35
4211	5	7
4221	25	35
4611	5	7
4621	25	35

Table 1. Mounting bolt torques.

function with a thinner mounting, but the cell may not meet linearity, repeatability or hysteresis specifications on a thin mounting plate.

3. The surface should be ground to a flatness of 0.0002" T.I.R. If the plate is heat treated after grinding, it is always worthwhile to give the surface one more light grind to ensure flatness.
4. The mounting bolts should be Grade 8. If they can't be obtained locally, they can be ordered from the factory. For cells with counterbored mounting holes, use socket head cap screws. For all other cells, use hex head bolts. Do not use washers under the bolt heads.
5. First, tighten the bolts to 60% of the specified torque; next, torque to 90%; finally, finish at 100%. The mounting bolts should be torqued in sequence, as shown in Figures 11, 12, and 13. For cells having 4 mounting holes, use the pattern for the first 4 holes in the 8-hole pattern.

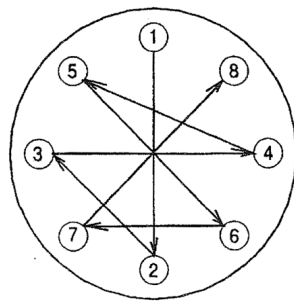

Figure 11. Mounting bolt torque sequence, 8 holes.

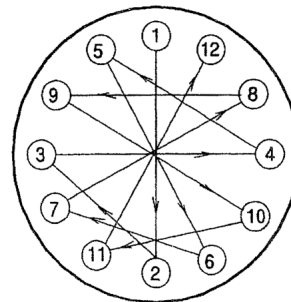

Figure 12. Mounting bolt torque sequence, 12 holes.

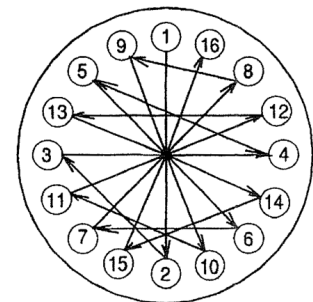

Figure 13. Mounting bolt torque sequence, 16 holes.

## Mounting Torques for Fixtures in Low Profile Cells

The torque values for mounting fixtures into the active ends of Low Profile load cells are not the same as the standard values found in tables for the materials involved. The reason for this difference is that the thin radial webs are the only structural members which restrain the center hub from rotating with relation to the periphery of the cell.

The safest way to achieve a firm thread-to-thread contact without damaging the cell is to apply a tensile load of 130 to 140 % of the load cell's capacity, set the jam nut firmly by applying a light torque to the jam nut, and then release the load.

Torques on the hubs of Low Profile cells should be limited by the following equation:

$$T_{MAX} = 0.4 \times C$$

Where:

$T_{MAX}$  = allowed torque (in-lb)

$C$  = Rated Capacity of the load cell (lbf)

For example, the hub of a 1000 lbf Low Profile cell should not be subjected to more than 400 in-lb of torque.

**CAUTION**

Application of excessive torque could shear the bond between the edge of the sealing diaphragm and the flexure. It could also cause a permanent distortion of the radial webs, which could affect the calibration but might not show up as a shift in the zero balance of the load cell.

## **LOAD CELL CHARACTERISTICS AND APPLICATIONS**

### **Load Cell Stiffness**

Frequently, customers want to use a load cell as an element in the physical structure of a machine or assembly. Therefore, they would like to know how the cell would react to the forces developed during the assembly and operation of the machine.

For the other parts of such a machine, made from stock materials, the designer can look up their physical characteristics (such as thermal expansion, hardness, and stiffness) in handbooks and determine the interactions of his parts based on his design. However, since a load cell is built on a flexure, which is a complex machined part whose details are unknown to the customer, its reaction to forces will be difficult for the customer to determine.

It is a useful exercise to consider how a simple flexure responds to loads applied in different directions. Figure 14 shows examples of a simple flexure, made by grinding a cylindrical groove into both sides of a piece of steel stock. Variations of this idea are used extensively in machines and test stands to isolate load cells from side loads. In this example, the simple flexure represents a member in a machine design, not an actual load cell.

The thin section of the simple flexure acts as a virtual frictionless bearing having a small rotational spring constant. Therefore, the spring constant of the material may have to be measured and factored into the response characteristics of the machine.

If we apply a tensile force,  $F_n$  or a compressive force,  $F_c$ , to the flexure at an angle off of its centerline, the flexure will be distorted sideways by the vector component,  $F_{TX}$  or  $F_{cX}$ , as shown by the dotted outline. Although the results looks quite similar for both cases, they are drastically different.

In the tensile case in Figure 14, the flexure tends to bend into alignment with the off-axis force and the flexure assumes an equilibrium position safely, even under considerable tension.

In the compressive case, the flexure's reaction, as shown in Figure 15, can be highly destructive, even though the applied force is exactly the same magnitude and is applied along the same line of action as the tensile force, because the flexure bends away from the line of action of the applied force. This tends to increase the side force,  $F'_{ex}$ , with the result that the flexure bends even more. If the side force exceeds the ability of the flexure to resist the turning motion, the flexure will continue to bend and will ultimately fail. Thus, the failure mode in compression is bending collapse, and will occur at a much lower force than can be safely applied in tension.

The lesson to be learned from this example is that extreme caution must be applied when designing compressive load cell applications using columnar structures. Slight misalignments can be magnified by the motion of the column under compressive loading, and the result can range from measurement errors to complete failure of the structure.

The previous example demonstrates one of the major advantages of the Interface Low Profile cell design. Since the cell is so short in relation to its diameter, it does not behave like a column cell under compressive loading. It is much more tolerant of misaligned loading than a column cell.

The stiffness of any load cell along its primary axis, the normal measurement axis, can be calculated easily, given the rated capacity of the cell and its deflection at rated load. Load cell deflection data can be found in the Interface Catalog.

**NOTE**

Keep in mind that these values are typical, but are not controlled specifications for the load cells. In general, the deflections are characteristics of the flexure design, the flexure material, the gage factors and the final calibration of the cell. These parameters are each individually controlled, but the cumulative effect may have some variability.

Using the SSM-100 flexure in Figure 16 as an example, the stiffness in the “Z” direction (the primary axis) can be calculated as follows:

$$S_Z = \frac{C_R}{D_{RO}}$$

Where:

$S_Z$  = Stiffness on primary axis

$C_R$  = Rated Capacity

$D_{RO}$  = Deflection at Rated Output

For the SSM-100:

$$S_z = \frac{100}{0.004}$$
$$= 25,000 \text{ lb/in}$$

This type of calculation is true for any linear load cell on its primary axis. In contrast, the stiffnesses of the “X” and “Y” axes are much more complicated to determine theoretically, and they are not usually of interest for users of Mini Cells, for the simple reason that the response of the cells on those two axes is not controlled as it is for the Low Profile series. For Mini Cells, it is always advisable to avoid the application of side loads as much as possible, because the coupling of off-axis loads into the primary axis output can introduce errors into the measurements.

For example, application of the side load,  $F_x$ , causes the gages at “A” to see tension, and the gages at “B” to see compression. If the flexures at “A” and “B” were identical and the gage factors of the gages at “A” and “B” were matched, we would expect the output of the cell to cancel the effect of the side load. However, since the SSM series is a low-cost utility cell which is typically used in applications having low side loads, the extra cost to the customer of balancing out the side load sensitivity is usually not justifiable.

The correct solution where side loads or moment loads may occur is to uncouple the load cell from those extraneous forces by the use of a rod end bearing at one or both of the ends of the load cell.

For example, Figure 17 shows a typical load cell installation for weight of a barrel of fuel sitting on a weigh pan, in order to weigh the fuel used in engine tests.

A clevis is mounted firmly to the support beam by its stud. The rod end bearing is free to rotate around the axis of its support pin, and can also move about  $\pm 10$  degrees in rotation both in and out of the page and around the primary axis of the load cell. These freedoms of motion ensure that the tension load stays on the same centerline as the load cell’s primary axis even if the load is not properly centered on the weigh pan.

Note that the nameplate on the load cell reads upside down, because the dead end of the cell must be mounted to the support end of the system.

## Load Cell Natural Frequency: Lightly Loaded Case

Frequently, a load cell will be used in a situation where a light load, such as a weigh pan or small test fixture will be attached to the live end of the cell. The user would like to know how quickly the cell will respond to a change in loading. By connecting the output of a load cell to an oscilloscope and running a simple test, we can learn some facts about the dynamic response of the cell. If we firmly mount the cell on a massive block and then tap the cell’s active end very lightly with a tiny hammer, we will see a damped sine wave train (a series of sine waves which progressively decrease to zero).



**NOTE**

Use extreme caution when applying impact to a load cell. The force levels can damage the cell, even for very short intervals.

The frequency (number of cycles occurring in one second) of the vibration can be determined by measuring the time ( $T$ ) of one complete cycle, from one positive-going zero crossing to the next. One cycle is indicated on the oscilloscope picture in Figure 18 by the bold trace line. Knowing the period (time for one cycle), we can calculate “ $f_o$ ” (the natural frequency of free oscillation of the load cell) from the formula:

$$f_o = \frac{1}{T}$$

Where:

$f_o$  = natural frequency

$T$  = time for one cycle

The natural frequency of a load cell is of interest, because we can use its value to estimate the dynamic response of the load cell in a lightly loaded system.

**NOTE**

Natural frequencies are typical values, but are not a controlled specification. They are given in the Interface catalog only as an assistance to the user.

The equivalent spring-mass system of a load cell is shown in Figure 19. The mass,  $m_b$ , corresponds to the mass of the live end of the cell, from the attachment point to the thin sections of the flexure. The spring, having spring constant  $K$ , represents the spring rate of the thin measurement section of the flexure. The mass,  $m_2$ , represents the added mass of any fixtures which are attached to the live end of the load cell.

Figure 20 relates these theoretical masses to the actual masses in a real load cell system. Note that the spring constant,  $K$ , occurs on the dividing line at the thin section of the flexure.

Natural frequency is a basic parameter, the result of the design of the load cell, so the user must understand that the addition of any mass on the active end of the load cell will have the effect of lowering the total system’s natural frequency. For example, we can imagine pulling down slightly on the mass  $m_1$ , in Figure 19, and then letting go. The mass will oscillate up and down at a frequency determined by the spring constant,  $K$ , and the mass of  $m_1$ . In fact, the oscillations will damp out as time progresses in much the same way as in Figure 18.

If we now bolt the mass  $m_2$  on  $m_1$ , the increased mass loading will lower the natural frequency of the spring-mass system. Fortunately, if we know the masses of  $m_1$  and  $m_2$ , and the natural frequency of the original spring-mass combination, we can calculate the amount that the natural frequency will be lowered by the addition of  $m_2$ , according to the formula:

$$f_s = f_o \sqrt{\frac{m_1}{m_1 + m_2}}$$

Where:

$f_s$  = system natural frequency

$f_o$  = load cell natural frequency

$m_1$  = load cell live end mass

$m_2$  = added fixture mass

To an electrical or electronic engineer, the static calibration is a “DC” parameter, whereas the dynamic response is an “AC” parameter. This is represented in Figure 21, where the DC calibration is shown on the factory calibration certificate, and users would like to know what the response of the cell will be at some driving frequency they will be using in their tests.

Note the equal spacing of the “Frequency” and “Output” grid lines on the graph in Figure 21. Both of these are logarithmic functions; that is, they represent a factor of 10 from one grid line to the next. For example, “0 db” means “no change”; “+20 db” means “10 times as much as 0 db”; “-20 db” means “1/10 as much as 0 db”; “-40 db” means “1/100 as much as 0 db.”

By using logarithmic scaling, we can show a larger range of values, and the more common characteristics turn out to be straight lines on the graph. For example, the dashed line shows the general slope of the response curve above the natural frequency. If we continued the graph down and off to the right, the response would become asymptotic (closer and closer) to the dashed straight line.

#### **NOTE**

The curve in Figure 21 is provided only to portray the typical response of a lightly loaded load cell under optimum conditions. In most installations, the resonances in the attaching fixtures, test frame, driving mechanism and UUT (unit under test) will predominate over the load cell’s response.

## **Load Cell Natural Frequency: Heavily Loaded Case**

In cases where the load cell is mechanically tightly coupled into a system where the masses of the components are significantly heavier than the load cell’s own mass, the load cell tends more to act like a simple spring which connects the driving element to the driven element in the system.

The problem for the system designer becomes one of analyzing the masses in the system and their interaction with the very stiff spring constant of the load cell. There is

no direct correlation between the load cell's unloaded natural frequency and the heavily loaded resonances which will be seen in the user's system.

## Contact Resonance

Almost everyone has bounced a basketball and noticed that the period (time between cycles) is shorter when the ball is bounced closer to the floor. Anyone who has played a pinball machine has seen the ball rattling back and forth between two of the metal posts; the closer the posts get to the diameter of the ball, the faster the ball will rattle. Both of these resonance effects are driven by the same elements: a mass, a free gap, and a springy contact which reverses the direction of travel.

The frequency of oscillation is proportional to the stiffness of the restoring force, and inversely proportional both to the size of the gap and to the mass. This same resonance effect can be found in many machines, and the buildup of oscillations can damage the machine during normal operation.

For example, in Figure 23 a dynamometer is used to measure the horsepower of a gasoline engine. The engine under test drives a water brake whose output shaft is connected to a radius arm. The arm is free to rotate, but is constrained by the load cell. Knowing the RPM of the engine, the force on the load cell, and the length of the radius arm, we can calculate the horsepower of the engine.

If we look at the detail of the clearance between the ball of the rod end bearing and the sleeve of the rod end bearing in Figure 23, we will find a clearance dimension,  $liD$ , because of the difference in size of the ball and its constraining sleeve. The sum of the two ball clearances, plus any other looseness in the system, will be the total  $IIgapII$  which can cause a contact resonance with the mass of the radius arm and the spring rate of the load cell.

As the engine speed is increased, we may find a certain RPM at which the rate of firing of the engine's cylinders matches the contact resonance frequency of the dynamometer. If we hold that RPM, magnification (multiplication of the forces) will occur, a contact oscillation will build up, and impact forces of ten or more times the average force could easily be imposed on the load cell.

This effect will be more pronounced when testing a one-cylinder lawn mower engine than when testing an eight cylinder auto engine, because the firing impulses are smoothed out as they overlap in the auto engine. In general, raising the resonant frequency will improve the dynamic response of the dynamometer.

The effect of contact resonance can be minimized by:

- Using high quality rod end bearings which have very low play between the ball and socket.
- Tightening the rod end bearing bolt to ensure that the ball is tightly clamped in place.
- Making the dynamometer frame as stiff as possible.

- Using a higher capacity load cell to increase the load cell stiffness.

## Application of Calibration Loads: Conditioning the Cell

Any transducer which depends upon the deflection of a metal for its operation, such as a load cell, torque transducer or pressure transducer, retains a history of its previous loadings. This effect occurs because the minute motions of the crystalline structure of the metal, small as they are, actually have a frictional component which shows up as hysteresis (non-repeating of measurements which are taken from different directions).

Prior to the calibration run, the history can be swept out of the load cell by the application of three loadings, from zero to a load which exceeds the highest load in the calibration run. Usually, at least one load of 1300/0 to 140% of the Rated Capacity is applied, to allow the proper setting and jamming of the test fixtures into the load cell.

If the load cell is conditioned and the loadings are properly done, a curve having the characteristics of A-B-C-D-E-F-G-H-I-J-A, as in Figure 24, will be obtained. The points will all fall onto a smooth curve, and the curve will be closed on the return to zero. Furthermore, if the test is repeated and the loadings are properly done, the corresponding points between the first and second runs will fall very close to each other, demonstrating the repeatability of the measurements.

## Application of Calibration Loads: Impacts and Hysteresis

Whenever a calibration run yields results which don't have a smooth curve, don't repeat well, or don't return to zero, the test setup or loading procedure should be the first place to check.

For example, Figure 24 shows the result of the application of loads where the operator was not careful when the 60% load was applied. If the weight was dropped slightly onto the loading rack and applied an impact of 80% load and then returned to the 600/0 point, the load cell would be operating on a minor hysteresis loop which would end up at point "P" instead of at point "D." Continuing the test, the 80% point would end up at "R," and the 1000/0 point would end up at "S." The descending points would all fall above the correct points, and the return to zero would not be closed.

The same type of error can occur on a hydraulic test frame if the operator overshoots the correct setting and then leaks back the pressure to the correct point. The only recourse for impacting or overshooting is to recondition the cell and start the test over.

## Test Protocols and Calibrations

Load cells are routinely conditioned in one mode (either tension or compression), and then calibrated in that mode. If a calibration in the opposite mode is also required, the cell is first conditioned in that mode prior to the second calibration. Thus, the calibration data reflects the operation of the cell only when it is conditioned in the mode in question.

For this reason, it is important to determine the test protocol (the sequence of load applications) which the customer is planning to use, before a rational discussion of the possible sources of error can occur. In many cases, a special factory acceptance must be devised to ensure that the user's requirements will be met.

For very stringent applications, users are generally able to correct their test data for the nonlinearity of the load cell, thus removing a substantial amount of the total error. If they are unable to do so, nonlinearity will be part of their error budget.

Nonrepeatability is essentially a function of the resolution and stability of the user's signal conditioning electronics. Load cells typically have nonrepeatability which is better than the load frames, fixtures and electronics used to measure it.

The remaining source of error, hysteresis, is highly dependent on the loading sequence in the user's test protocol. In many cases, it is possible to optimize the test protocol so as to minimize the introduction of unwanted hysteresis into the measurements.

However, there are cases where users are constrained, either by an external customer requirement or by an internal product specification, to operate a load cell in an undefined way which will result in unknown hysteresis effects. In this event, the user will have to accept the worst case hysteresis as an operating specification.

Also, some cells must be operated in both modes (tension and compression) during their normal use cycle without being able to recondition the cell before changing modes. This results in a condition called toggle . (non-return to zero after looping through both modes). In normal factory output, the magnitude of toggle is a broad range where the worst case is approximately equal to or ~lightly larger than hysteresis, depending on the load cell's flexure material and capacity.

Fortunately, there are several solutions to the toggle problem:

- Use a higher capacity load cell so it can operate over a smaller range of its capacity. Toggle is lower when the excursion into the opposite mode is a smaller percentage of rated capacity.
- Use a cell made from a lower toggle material. Contact the factory for recommendations.
- Specify a selection criterion for normal factory production. Most cells have a range of toggle which may yield enough units from the normal distribution. Depending on the factory build rate, the cost for this selection is usually quite reasonable.
- Specify a tighter specification and have the factory quote a special run.

## **Application of In-Use Loads: On-Axis Loading**

All on-axis loadings generate some level, no matter how small, of off-axis extraneous components. The amount of this extraneous loading is a function of the tolerancing of the parts in the design of the machine or load frame, the precision with which the components are manufactured, the care with which the elements of the machine are

aligned during assembly, the rigidity of the load-bearing parts, and the adequacy of the attaching hardware.

## Control of Off-Axis Loads

The user can opt to design the system so as to eliminate or reduce off-axis loading on the load cells, even if the structure suffers distortion under load. In tension mode, this is possible by the use of rod end bearings with clevises.

Where the load cell can be kept separate from the structure of the test frame, it can be used in compression mode, which almost eliminates the application of off axis load components to the cell. However, in no case can off-axis loads be completely eliminated, because the deflection of load carrying members will always occur, and there will always be a certain amount of friction between the load button and the loading plate which can transmit side loads into the cell.

When in doubt, the Low Profile cell will always be the cell of choice unless the overall system error budget allows a generous margin for extraneous loads.

## Reducing Extraneous Loading Effects by Optimizing Design

In high-precision test applications, a rigid structure with low extraneous loading can be achieved by the use of ground flexures to build the measurement frame. Of course, this requires precision machining and assembly of the frame, at considerable cost.

## Overload Capacity with Extraneous Loading

One serious effect of off-axis loading is the reduction of the cell's overload capacity. The typical 150% overload rating on a standard load cell or the 300% overload rating on a fatigue-rated cell is the allowed load on the primary axis, without any side loads, moments or torques applied to the cell concurrently. This is because the off-axis vectors will add with the on-axis load vector, and the vector sum can cause an overload condition in one or more of the gaged areas in the flexure.

To find the allowed on-axis overload capacity when the extraneous loads are known, compute the on-axis component of the extraneous loads and algebraically subtract them from the rated overload capacity, being careful to keep in mind in which mode (tension or compression) the cell is being loaded.

## Impact Loads

Neophytes in the use of load cells frequently destroy one before an old-timer has a chance to warn them about impact loads. We would all wish that a load cell could absorb at least a very short impact without damage, but the reality is that, if the live end of the cell moves more than 150% of the full capacity deflection in relation to the dead

end, the cell could be overloaded, no matter how short the interval over which the overload occurs.

In Panel 1 of the example in Figure 24, a steel ball of mass “m” is dropped from height “S” onto the live end of the load cell. During the fall, the ball is accelerated by gravity and has achieved a velocity “v” by the instant it makes contact with the surface of the cell.

In Panel 2, the velocity of the ball will be completely stopped, and in Panel 3 the direction of the ball will be reversed. All this must happen in the distance it takes for the load cell to reach the rated overload capacity, or the cell may be damaged.

In the example shown, we have picked a cell which can deflect a maximum of 0.002” before being overloaded. In order for the ball to be completely stopped in such a short distance, the cell must exert a tremendous force on the ball. If the ball weighs one pound and it is dropped one foot onto the cell, the graph of Figure 26 tells us that the cell will receive an impact of 6,000 lbf (It is assumed that the mass of the ball is much larger than the mass of the live end of the load cell, which is usually the case.)

The scaling of the graph can be modified mentally by keeping in mind that the impact varies directly with the mass and with the square of the distance dropped.

## **MULTI-CELL STATIC OR WEIGHING APPLICATIONS**

Compression cells are widely used for weighing applications because they are less expensive and in some cases have slightly lower errors. Figure 27 shows a typical application. The load cell with base is mounted on the stud which is permanently affixed in the bottom plate. This gives the cell added protection against any uneven surface under the bottom plate which might affect the calibration of the cell.

The load cell’s load button is hard anodized or heat treated to ensure a hard surface. The load bearing surface of the top plate must be heat treated to increase its hardness. Cold rolled steel or similar material is not appropriate, because the surface will soon gall and become useless. Also, the finish of both the top plate’s bearing surface and load cell’s load button should have 32  $\mu$ inch or smoother surface roughness to ensure that galling will not occur.

The configuration of Figure 27 is widely used because the cell with base can be removed as a complete assembly by screwing it off of the bottom plate’s stud. When it is replaced, the original factory calibration of the new cell can be preserved, because the base protects the load cell against any unevenness in the surface facing the bottom of the base.

The configuration of Figure 28 is used in situations where the bottom surface of the hopper leg which bears on the load cell/bottom plate assembly can be machined flat

and smooth. This allows the load cell to be mounted directly on the bottom plate, without an intervening base, thus saving the cost of a base. Although conceptually simpler, this configuration requires that the bottom plate be installed at the factory so that the assembly can be calibrated. This configuration also protects the diaphragm surface of the load cell from being subjected to standing water in installations having water misting or splashing.

The majority of compression cell applications are multiple-cell installations. The number of cells may run anywhere from 3 cells on a simple weighing platform to 16 cells on a long truck scale.

In every case, the accuracy and repeatability of the system will be improved by following these simple rules:

1. Use a junction box which has balancing adjustment potentiometers.
2. Buy load cells which have “Standardized Output,” so that they can be “corner adjusted” either in the factory or when they are installed.
3. In any installation having more than three load cells, shim the low corner of each group of 4 cells until all the cells are sharing the load equally within 10%.
4. Perform a corner adjustment after the cells are shimmed, if it was not done at the factory.

## Equalizing the Loads in Multiple-Cell Systems

When designing the mechanical mounting of the cells in a multiple-cell system, provisions should be made for the leveling adjustment necessary to equalize the loading of the cells among all the “corners” of the system. (In this context, all the cells in a multicell system are called “corners,” even though some of them may be on sides, between corners.) It is advantageous that all the cells operate at the same point on their operating curves, by being equally loaded, in order to achieve maximum system accuracy.

Everyone has had the experience of sitting on a four-legged chair which has one slightly short leg, and getting the feeling of rocking back and forth with one or the other leg always off the floor. Although we think that our weight is being carried by three of the four legs, in truth almost our whole weight is sometimes on only two of the legs. The same effect can be seen on a multiple-cell system which has been improperly shimmed.

### **CAUTION**

In an improperly equalized four-cell system, it is possible that the total load could be carried momentarily by two diagonally opposite load cells, which would be almost certain to overload the cells.

The “rocking chair” effect will be more or less pronounced, depending on the stiffness of the framework or structure which transmits the load to the cells.

For example, we can construct a very stiff system by making a tank out of a thick-walled steel pipe four feet in diameter, with a flat bottom welded inside it part way up



from the bottom, as in Figure 30. The bottom edge of the pipe is prepared by having hard inserts welded into it to match the locations of the load buttons on the load cells, and the inserts are carefully ground to a planar surface. The four load cells are mounted on a very thick, stiff steel plate which has been ground as flat as humanly possible.

As the pipe is slowly and carefully lowered onto the cells, we find to our dismay that two diagonally opposite cells are taking much more load than the other two cells. This is happening because the full scale deflection of the load cells is only a few thousandths of an inch, and it is too costly, if not impossible, to grind the surfaces of the plate and the tank that flat over such a large span to that close a tolerance.

If we had any intention of shimming the cells to equalize the loading, we would need to use shims that are only about 1/5 the thickness of a piece of paper. Such a task would take days to accomplish. In addition, distortion of the tank by temperature gradients (uneven changes in temperature) in the tank when the sun shines on it or when hot liquid is pumped into it would introduce dramatic changes in the careful job of shimming which we had just finished.

The important lesson to be learned from this example is that there needs to be some flexibility built into the design of the tank structure to make the shimming job easier and to reduce the effect on the cell loading caused by temperature gradients distorting the tank. Figure 31 simulates a springy system by actually picturing springs under the legs, which makes it easier to visualize how a springy frame alleviates the shimming problem.

We can now calculate the effect of the addition of a shim which is 0.002" thick. Let's assume a 10,000 lbf load cell with a deflection of 0.002" at full capacity, which gives it a stiffness of 5 million pounds per inch.

In the "stiff" case of Figure 30, adding or removing one shim only 0.002" thick would change the load on that cell by 5,000 lbf. Thus, it would be very difficult to adjust the loading on the cell in increments of 5% of full capacity. (The reader is left with the problem of figuring out why the change in loading is only 1/2 of the "expected" value.)

Now, let's assume that the springs in Figure 31 have been chosen to have a stiffness of 50,000 pounds per inch, 1/100th of the stiffness of the load cells. When we first lower the frame onto the cells, the springs will alleviate much of the uneven loading on the cells. In addition, as we check the cells' outputs, we find that the addition of a shim of 0.002" thickness raises the loading on that cell by 50 lbf, well within the equalization increment of 5% of full capacity which we were shooting for.

Equalizing a tension system is a much easier task than shimming a compression system. The load cells will all be moment protected, either by the use of rod end bearings and clevises or by using flexible cable assemblies on each cell. It is then necessary only to insert a turnbuckle in one of the supports on a four-cell system, two of the supports in a five-cell system, or three of the supports in a six-cell system. Since one-, two-, or three cell systems do not need physical shimming adjustment, they are obviously much easier

to install, and are hardly affected by distortions due to temperature gradients in the support framework.

## Corner Adjustment of Multiple-Cell Systems

After the cells have all been equalized, an electrical corner adjustment will be needed on most systems unless it has already been done at the factory.

### **NOTE**

Do not change any adjustments on a system which has already been calibrated at the factory. The factory calibration will be lost.

Corner adjustment is accomplished as follows:

1. Apply power to the system and make sure that the excitation voltage is the specified value, when measured at the point of voltage sensing in the system.
2. Turn all the adjustment pots in the junction box to the zero resistance point.
3. Empty the vessel, tank or hopper as much as possible.
4. Measure the output of all the load cells separately and record their values. This can be done by disconnecting only one wire, the +Out wire (green) for each cell in the junction box and reading the voltage between the +Out (green) and –Out (white) wires. (In special applications, the wire colors may be different. Check the installation documentation.)
5. Apply the largest weight within the capacity of the individual load cells as close to one cell as physically possible. Record the output. Repeat for each cell, using the same weight each time.
6. Calculate the incremental output (the difference between the loaded and unloaded readings) for each cell.
7. Note which cell has the lowest incremental output.
8. Apply the same weight again to the higher reading cells, and adjust each cell's output down to match the lowest cell, by adjusting that cell's pot.
9. Repeat the check again, starting at Step 5, on all except the lowest cell, and adjust as necessary to match the lowest cell.
10. Reconnect the wiring, and have the system calibrated using in-house procedures.

## Moment Compensated Platform

In the same way that a load cell can have moment sensitivity (output variation for off-axis loads), a weigh platform can respond differently for loads which are not exactly on the center of the platform. In the case of Figure 32, where the three load cells are equally spaced around the bolt circle with radius “R,” if the outputs of the cells are corner adjusted properly, the weight indication of the platform will be the same for any location of a test weight. This fact would seem to be intuitively true, simply because of the symmetry of the load cell layout.

But, when we propose the layout of Figure 33, the lack of rotational symmetry strains our intuition, and we may struggle with the concept that the only criterion for a successful weigh platform is that the cells are corner adjusted. However, strict mathematical analysis of either system yields the same answer: corner adjustment alone is sufficient.

There may be a functionally logical reason for the arrangement of Figure 33, or even Figure 34. In many cases, the load may be applied from a particular edge or a motor/gear assembly may be mounted off-center, and the concentration of cells closer together tends to distribute the load between the three cells more evenly.

The dimensions in Figure 34 are correct for an evenly loaded conveyor frame where the loads are dumped onto frame at the left end, on the line connecting the two cells. This arrangement gives more margin to protect the cells from overload. Incidentally, the load is equally divided among the cells when there is no product on the conveyor (tare condition) or the load is at the center mark of the conveyor.

The reader may have noticed that all the examples in this section use only three cells. Most applications can be solved by a three-cell arrangement, unless the designer failed to consult with the load cell supplier early enough in the design phase of the project and ended up with a hopper or tank structure which was driven by the idea of a square section with four legs. Given the difficulty of equalizing or shimming a four-cell system and the effects of temperature gradients on the measurements, eliminating one cell is sometimes a major improvement in the design.

## One-Cell Systems

Many applications can be easily implemented with either a two-cell or a one-cell arrangement, provided the justification criteria are met. This section outlines how these cost saving systems can be specified and designed.

The simplest one-cell system is the tension cell mounted through rod end bearings and clevises as shown in Figure 17. If the cell is properly oriented with the dead end going to the support, the only other major consideration is the elimination or reduction of possible parallel load paths, which are covered in the section on “Parallel Load Paths.”

The high-impact platform of Figure 35 combines the low cost of a one-cell system with the ability to withstand the impact of the rough treatment from handlers of large drums, LPG tanks, etc. The disadvantage of the system is that the CG (center of gravity) of the load must be placed on the mark for the calibration of the system to hold true. This can be accomplished by positioning the fences so that the CG of the particular product is located properly when the drum is shoved up against the fences. Two or more products which have different drum diameters can be accommodated by having movable fences with stop pins to position them correctly for each load or by using the multiple-cell capability in the 9840 Smart Indicator by setting up a scale factor for each drum diameter.

The actual load at the CG of the drum will be factored by the lever arm:

$$L_I = L_T \times \frac{D_2}{D_1 + D_2}$$

Where:

$L_I$  = Indicated Load

$L_T$  = True Load

$D_1$  = Distance from load CG to Load Cell

$D_2$  = Distance from load CG to Hinge Line

This concept has been used successfully for systems handling drums in the range of 180 to 400 pounds. For stubborn impact cases, the load cell can be configured with overload protection or the overload protection can be built into the platform as shown in Figure 36. The overload gap should be about 0.05” to 0.1 ,” and the spring constant of the flat spring should be such that a load of 110% of the load cell’s capacity will cause the platform to hit the stop block, thus shunting the excess load around the load cell.

The concept of the single-cell system works simply because the location of the center of gravity is under control. As long as the force on the primary axis of the load cell bears the same relation to the location of the CG of the load under all conditions, the scaling will be correct.

In the tension system, the CG is always directly under the load cell because the rod end bearing forces it to be there.

In the compression system, we can control the location of the CG if we know the drum diameter, by using fences. However, one additional criterion must be met: the CG must project down to the same location on the platform at any level of filling in the container. For homogeneous materials like liquids in a truly vertical cylindrical container, this will always occur. However, errors can be introduced if the platform is not level, if the container is distorted, or if any other condition causes the CG to “wander” as the container is filled.

## Two-Cell Systems

In the two-cell system of Figure 37, the weighing rail is supported by the load cells, which are bolted to the main rails. This construction is typical of a warehouse or meat packing plant, where the product is moved around by hanging it on a hook which rides on a rail. The rail has one section which is totally supported by two load cells.

### **NOTE**

The gap at each end of the weighing rail is vee-shaped, to avoid an impact when the trolley wheel rides across the gap.

As in any system where failure of any of the components could result in damage to equipment or injury to personnel, the weighing section overlaps in such a way that it will be always be supported even if a load cell fails. The general rule on the equipment, other than the load cells, is that the system is proof tested at a load which is five times the operating specification. Naturally, the load cells would be destroyed by such a test, so the system must be designed to retain its integrity even if a load cell fails.

## Parallel Paths: Pipes, Conduit, and Check Rods

In the optimum design of any system using load cells, all parallel paths (load carrying paths outside the load cells) should be avoided. In cases where parallel paths carry part of the load, any variability in that load will be reflected in an equal error in the load measured by the load cells.

Especially in weighing systems, it is very difficult to avoid parallel paths completely. This is true because most hoppers have some type of power-driven device which requires a connection to the main AC power system or a piping connection for carrying the material into or out of the hopper.

Before the basic design of a weighing tank or hopper is frozen, the support structure and loading/unloading mechanisms should also be evaluated to ensure that none of the parallel paths (pipes, conduit and check rods) will introduce excessive errors into the weighing system.

For example, Figure 38 shows a vibrator (a motor with an off-center flywheel) to shake loose the powdery material in the hopper, and a screwfeeder (a long screw inside a pipe which feeds material when turned by the motor/gearbox assembly). The power wiring for both of these devices should be in flexible conduit, if allowed by the local code, and the weight of the conduit should be supported as shown to relieve the hopper from as much of the weight of the conduit as possible.

Figure 39 illustrates three types of uses for compressed air on a hopper. The upper supply injects air through jets in the side of the hopper to fluidize (mix air into a powder or slurry) to make it act like a low-viscosity fluid. The pneumatic valve is a sliding door driven by a pneumatic cylinder. Both of these should be connected to the air supply through flexible hoses, because they are parallel paths to the hopper.

The outlet pipe is connected to the hopper through a bellows, to remove the pipe as a parallel path. The connection to inject air into the outlet pipe need not be flexible, because is outside the weighing loop. The electrical wiring to control the solenoid valves is a generally a small enough gauge that it can be neglected.

## Paralleling Two or More Cells

### Universal Cells

At first glance it would seem that two or more load cells could simply be mounted between parallel plates to create a single assembly with increased capacity, when a larger

cell is not available. Unfortunately, this is not the case, and many cells have been destroyed by hidden overloads in this situation.

In addition, unless the assembly is carefully and properly done, errors which are not obvious can be generated, and the output of the assembly could exhibit nonrepeatability, hysteresis, nonlinearity, zero balance instability, and temperature variability which are higher than would normally be seen in a single cell.

These errors would be the result of the introduction of stresses into the load cells by the process of bolting the load cells into the assembly. A single cell is carefully constructed to be free of internal stresses when at the zero balance condition.

Figure 40 illustrates what happens if the heights of all the hubs in the assembly are not exactly matched when the assembly is torqued tight.

Detail/Section A-A gives an exaggerated picture to demonstrate what happens as the stud in Cell B is tightened to close the gap created by its short hub. Cell B's zero balance shifts in the tension direction because of the tension in the stud to close the gap.

But, that level of tension in the stud is not sufficient to provide a reliable assembly. We must continue to tighten the assembly until the surface of the upper plate and the surface of the load cell hub are flat-to-flat. This results in the introduction of a large moment torque into the load cell. Since the cell is designed to cancel moment inputs, the user may not see a shift in the output due to this moment, but some of the radial beams in the cell could be experiencing a high stress which could destroy the cell in later use.

#### **CAUTION**

The multi-cell assembly will be extremely sensitive to temperature gradients which are introduced by exposing one of the mounting plates to heating without heating the other plate. For example, leaving the assembly in the sun will result in differential expansion between the two plates which could very likely destroy the load cells.

In the event that it is absolutely necessary to parallel two or more cells, the following steps should be followed explicitly.

1. The plates should be made from 4340 steel plate. Each plate should be at least 1.5 times the nominal thickness of the base which is normally used for the load cells. This is to reduce the amount of bowing of the plates when loads are applied.
2. The bottom surface of the upper plate and the top surface of the lower plate should be ground to a flatness of 0.0005" T.I.R. and a surface finish of 32  $\mu$ inch.
3. Drill and tap the loading hole in the center of both plates.
4. Drill holes for mounting the cells onto the lower plate. The holes should be on a bolt circle which is centered on the loading hole so that the loads will be distributed equally into all the load cells from the central loading point.

5. Heat treat both plates to a hardness of Rockwell C 33-37.
6. Using Class 3 Socket Drive Set Screws for the tensioning studs, mount the load cells on the lower plate according to the published torque specifications. The studs should be at least long enough to provide square thread engagement beyond the jam nut. Screw the studs into the bases until they hit the stop plug, and then back out one turn. Apply the specified torque to the jam nut.
7. Block up the lower plate assembly (plate plus load cells) on a grinder and indicate the top surface of the plate. Shim the plate on the table of the grinder until the top surface of the plate measures less than 0.001" T.I.R., and check the plate assembly to make it is clamped securely.
8. Indicate the top surface of each load cell hub to find the lowest hub. Taking very slow feeds and light cuts, grind the top surface of the load cells' hubs until they are all ground down to the match the lowest hub. Continue to grind until the whole hub surface of the lowest hub has been ground. Allow the cells to cool and reach temperature equilibrium for at least 4 hours. Take one more slow pass to ensure that all the cells' hubs are in one plane within 0.0002" T.I.R., referenced to the surface of the grinder's table.
9. Place the upper plate in position and install the studs and jam nuts. If necessary, hold the studs from turning with an Allen wrench. Torque the jam nuts to a barely snug condition, 5 to 10 lb-ft of torque. Do not attempt to apply jamming torque to the studs or the jam nuts at this time.
10. Mount the assembly in a load frame with a capacity of about twice the rated capacity of one of the load cells in the assembly, as shown in Figure 41.
11. Using the output of Cell "A" as a measure, apply a tension of 120 to 13a% of the rated capacity of Cell IIA." The jamming on the tension studs will be relieved by this force, and the jam nuts on both studs should then be tightened to 5-10 lb-ft of torque. Do not torque the jam nuts any tighter. When the tension is released, the studs' threads will be firmly set, and the jam nuts will be set properly.

**NOTE**

The actual force required to achieve the proper tension on the load cell during the tensioning operation will be higher than indicated on the load cell output, because of the deflection of the upper and lower plates required to bring the load cell beyond full capacity. The plates are restrained by the parallel paths of the other load cells in the assembly.

12. Repeat Step 11 for the other load cells in the assembly. Use the output of the load cell being tensioned as the indication of the force being applied to it.
13. When all the cells have been tensioned, measure and record the zero balance of each load cell.
14. Connect all the cells to the signal conditioner, cables, and junction box with which they were calibrated at the factory.
15. Mount the whole assembly on the load frame and apply a conditioning load of 100% of the theoretical capacity of the assembly through the loading holes.

Repeat the loading two more times. Measure and record the zero balance of each load cell individually.

16. Apply the conditioning load one more time and record the zero balances again.
17. Compare the zero balances for each load cell and verify that the last conditioning load resulted in only a minor shift in zero balance. If the shift was greater than 0.05% RO, the conditioning loads should be repeated.
18. The assembly is now ready for final calibration. The original factory calibration will be useful for comparison purposes, but it is not valid for the final assembly because the outputs of the load cells will be affected by the side loads and moment loads applied to the cells due to bowing of the upper and lower plates.

#### **CAUTION**

In a multilevel tension assembly, the rated capacity should be limited to 80% of the calculated theoretical capacity because of the unavoidable and unmeasurable residual stresses which are induced in the individual load cells by their being restrained between two stiff plates.

### **Compression Cells**

In a multi-cell compression system, the top plate is a ground and hardened steel plate, with a surface finish of 32  $\mu$ inch. It is merely resting on the load buttons of the cells. The paralleling of compression cells can be very straightforward, if these simple rules are followed:

1. For two cells, the upper plate must be supported from tipping, since it is not bolted to the top side of the compression cells ... it is just resting on their load buttons.
2. Three cells is the optimum number, because the three load buttons will provide a stable support for the upper plate.
3. Four or more cells are quite difficult to assemble, because the low cell must be shimmed until it makes all the load buttons lie in one plane within no worse than 0.0005.”
4. The requirements for the lower plate are the same as for the universal cells, given above.

## **MATERIALS AND PROCESS CONTROL TESTING**

The testing of materials and complex assemblies is such a vast field that it is impossible to cover all aspects of it completely in this manual. In this section, we will give an overview of the different types of material tests and other specialized tests using force as a variable, with some examples of the most common applications.



## Force Versus Deflection

In the determination of the force versus deflection characteristics of a raw material, a fabricated part, or an assembly, it is usually necessary to control the position and orientation of the UUT (Unit Under Test), to control the direction and magnitude of the applied force, to measure one or more displacements, and to measure any other parameter which may vary with the force or displacement. For these reasons, a large market has developed over the years for sophisticated testing machines and their associated fixtures, transducers, and signal conditioning and recording equipment.

In the typical materials testing machine shown in Figure 42, where the clamp is shown, various other fixtures can be attached to hold, or even rotate, the UUT during the test. Other transducers can be mounted to measure torque, angle, pressure or any parameter the customer is willing to pay for. It is not unusual to test for torque and linear force concurrently, and the Interface Low Profile cells are eminently suited for this because of their high rejection of extraneous loads.

With the hydraulic ram at a solid stop, the gear drive can be servo-controlled to advance the displacement at a very accurately controlled rate, to determine the time dependency of a material's characteristics. Or, with the gear drive locked, the hydraulic ram can apply a precise force profile, as controlled by the load cell.

In general, any modern test machine is programmed and controlled by its own internal microprocessor, with facilities for accepting large volumes of control information and transmitting high rates of measured data either to a local datalogger or to a network server for further processing.

## Shear Force Versus Compaction

In the determination of shear strength versus compaction of soils or construction materials, the object is to determine the shear strength as the material is used at different depths underground or at different levels in the construction of a high-rise building. Usually, a special test block is designed to test a particular type of material in conformance with a specification.

The test block is designed with a rectangular hole going through it, into which the tested material is inserted. To set up for the test, the shear block is put into position in the test block so that the hole in the shear block lines up with the rectangular test hole. The material under test is then packed into the hole, up through the hole in the shear block, and almost to the top of the test block. Finally, the compaction piston is inserted, and the material is evenly pressed down to fill the hole and remove air pockets and voids.

The actual test is performed in a test frame much like a materials test machine, except that it has an additional capability to pull out the shear block while measuring the shear force and shear deflection. To perform the test, the compaction force is first applied on the top of the compaction piston by a compression load cell, and then the tension shear force is applied to the shear block by another load cell. The test is

repeated for a range of compaction forces, and the output from the test is a table of figures or a graph of shear force versus compaction force.

## Peel Force

A common test for adhesives, adhesive-coated tapes, and paints is the peel test.

The test parameters are usually detailed in a government or industry specification, and the rate of pull is most often closely controlled. Adhesive-backed tapes are tested this way. Also, paint adhesion is tested by applying the paint according to instructions, applying a specified adhesive-backed tape to the painted surface, and then pulling the tape off in a specified way.

## Adhesive or Bonding Shear Force

There are literally thousands of adhesives and bonding agents which are used to assemble parts into assemblies. In addition to their bonding characteristics, they may be required to have a certain elasticity, resistance to chemicals, electrical conductivity, temperature coefficient, or other controlled parameter.

In addition to the general-purpose shear test machines on the market, many testers are designed and constructed in-house to perform specific tests on unique assemblies.

The design of a shear tester is relatively straightforward, as long as the following conditions are met:

1. The line of action of the primary axis of the load cell should be aligned with the contact point on the test sample, to minimize moment loads on the load cell.
2. The linear bearing motion should be carefully adjusted to run exactly parallel with the primary axis of the load cell, to avoid a side load into the load cell.
3. The load cell's capacity should be at least twice the expected maximum load to be applied during a test cycle, to provide enough extra capacity to protect the cell when a sudden failure of the test sample impacts the load cell.
4. The linear drive should have a wide range of controlled speeds and a high resolution displacement measuring capability, including an automatic adjustable stop with fast braking to protect the load cell from damage. A stepper motor drive with precision high-ratio reduction gear is the usual system of choice.

## Safety: Proof Testing and the Compression Cage

Many industry and government specifications require testing the components of a system at many times the rated or nameplate loading, where the failure of the component could result in costly damage to equipment or injury to personnel.

The most sensitive product liability area for load cell manufacturers is the use of a load cell in tension on a crane which lifts loads where it is possible that a person could be under the load, even by mistake. Proof testing in this case usually requires that the equipment be proof tested at five times its rating. Obviously, a tension load cell could never survive such a test. Interface never recommends using a tension load cell in this type of application.

The most straightforward solution, where it is necessary to measure the load in a tension cable subject to safety considerations is to enclose the load cell in a compression cage, which converts tension into compression. The compression cell is trapped between the two plates. Thus, the load cell's only overload failure mode is in compression, which allows a motion of only 0.001" to 0.010" before the load cell becomes solid. Even if the load cell is totally destroyed, the compression cage cannot drop the load unless it fails itself. Therefore, the cage can be proof tested with a dummy load cell, or an overload protected cell, and the risk of injury to personnel is avoided.

## Finding Center of Gravity

One of the critical tests on missile assemblies is the determination of the center of gravity, because variations in the weight distribution in a missile can have a disastrous effect on its flight stability.

The test stand shown in Figure 47 typifies the elements which need to be addressed to optimize the test.

1. Three cells instead of four will simplify the design, construction, and use of the test stand immeasurably.
2. The mounting ring should be as close as possible to the level of the center of gravity of the UUT. The farther the reference hard pads are displaced from the center of gravity, the more the test stand will be subject to errors due to leveling, misalignments, and temperature effects.
3. A calibration dummy load should be constructed which has the same weight as the UUT, and whose center of gravity is at exactly the required location. This will dramatically decrease errors due to nonlinearity of the load cells.
4. The test stand should be leveled each time it is used, and the cells should be carefully exercised with the dummy load and checked for calibration.

The designer who promotes a three-cell system may meet with some opposition from engineers whose minds are used to working in an orthogonal (right angled) reference system. However, the mechanical headaches associated with the shimming of a four-cell system and readjusting it when the temperature varies are worth the extra effort to solve the equations for a triangular system.

For example, if the CG (center of gravity) is supposed to be at the exact center of the triangular pattern of the load cells, the diagram in Figure 48 shows the load cells at ~ B, and C all measuring exactly the same loads  $c_x$ , P, and y. When those load vectors are plotted as distances from their respective opposite sides (which are the fulcrums

against which the vectors operate), we find that they coincide at the CG, at the exact centroid of the triangular load cell pattern.

This means that the CG is exactly where it should be, and it also gives us fair assurance that the system has been properly calibrated.

However, if the CG is mislocated in the missile, as in Figure 49, the vectors will define a different set of distances from their respective fulcrums. When we measure the vector  $c_x$  from the baseline BC, we construct line  $be$  parallel to the baseline BC. In the same manner, we construct line  $ae$  at distance from baseline AC. The intersection of lines  $ae$  and  $be$  defines the CG point.

The question then arises, “How did we find the CG without using line  $ab$ ?” The answer is, “Any two of the lines could define the CG, because the data from all three cells was used to define the two lines, and the intersection of two lines defines a point.”

The position of the third line is a redundant check, and is a nice way of checking the accuracy of the measurement. If the third line (whichever one we choose) does not go through the same point as the intersection of the first two lines, we need to check our test system and find the error, because all three lines should agree on the location of the eG. In Figure 49, the CG is mislocated, but all three lines agree on the intersection point. Thus, the test is good, but the CG is mislocated in the missile.

## FATIGUE TESTING

The use of load cells and a data logging system are a necessity in the majority of situations where materials, parts, or assemblies are fatigue tested to destruction. This is true because an accurate record of the forces at every moment of the tests is the only way that an engineer can analyze the stresses which occurred in the moments just prior to the ultimate failure. No one can accurately predict exactly when the failure will occur, nor which part of an assembly will be the weakest link which eventually fails.

When designing a test protocol, serious thought should be given to the possibility that some of the parameters of the test will need to be changed as the result of information learned in the early test cycles. It may be that the test frequencies, force levels, location or angle of force application, or phasing of test waves will need to be changed. It is therefore prudent to start out with equipment which can accommodate an increase, a decrease, or other change without a major redesign of fixtures or a major expenditure to convert or replace high cost test equipment.

### Fatigue Capacity

“Fatigue Rated” is an exact Interface specification which defines a special class of load cell design and construction.

1. Design stress levels in the flexures are about one-half as high as in a standard Low Profile load cell.
2. Internal high-stress points, such as sharp comers and edges, are specially polished to avoid crack propagation.
3. Extraneous load sensitivity is specified and adjusted to a lower level than in a standard Low Profile load cell.
4. All fatigue rated Interface Low Profile cells have a specified service life of 100 million fully reversed, full capacity loading cycles.

Not all manufacturers adhere strictly to the stringent discipline necessary to produce true fatigue rated load cells on a consistent basis. By contrast, the history of Interface Low Profile cells shows a zero return rate due to fatigue failure, for fatigue-rated cells used within ratings.

## Use of Non-Fatigued-Rated Cells in Fatigue Applications

Although Interface does not recommend it, there are times when circumstances force a user to apply a large number of test cycles on a non-fatigue-rated cell. The following guidelines may assist the user in deciding how long to carry on such a test before installing the properly sized fatigue-rated cell.

1. All Interface non-fatigue-rated load cells can be considered to have a useful life of at least one million cycles of single-mode loading (loading in only one direction), at full nameplate rating. Therefore, if used in single mode at 50% of rating, it is likely that a cell would survive at least ten million cycles.
2. If used at 500/0 of the cell's rating, the material used in steel and stainless steel Interface cells would be stressed below the endurance limit, the level at which the steel itself would resist failure indefinitely.

### **CAUTION**

If this were the only failure mode, any Interface steel or stainless steel cell could be used as a fatigue cell, if operated below 500/0 of its rated capacity. However, other minor failure modes would take over, because the load cell would be missing the "hand crafted" steps of the manufacturing process.

3. Aluminum alloy load cell material does not exhibit an endurance limit, the horizontal flattening of its S-N Curve, the operating curve of stress versus number of cycles to failure. Therefore, while use at 50% of rating will substantially increase the number of cycles it will withstand, no exact number of cycles can be predicted.
4. One failure mode which has not been tested on non-fatigue models is the number of cycles to failure of the connecting cable versus the excursion the cable is subjected to on each cycle. Users should take steps to support the cable in a way which reduces the stresses for larger excursions.
5. Since the application of dynamic forces during a test involves bi-directional motion, there is a larger risk of contact resonance due to clearances in the

driving mechanism. (See the section on Contact Resonance, page 14.) Any contact resonance generates non-sinusoidal forces having a high frequency content which has a greater effect on the cycle count on the load cell and also generates peak loads which are greater than the measured average.

## Fatigue Capacity With an Added Fixed Load

Many test protocols require a fixed load plus a dynamic load to be applied to a test sample simultaneously. An Interface fatigue-rated load cell is well suited to this type of application. However, there are limitations which should be applied to the loadings, to insure that the cell will be operating in its linear range and to avoid overloading the load cell or reducing its fatigue life.

The Goodman Curve shown in Figure 50 is a useful nomograph (visual calculating graph) for easily figuring combined loading limits for fatigue-rated cells. Notice that the dynamic loading limit by itself is 100% of the fatigue rating, and the static loading limit by itself is 2000/0 of the fatigue rating. In between these two end points, the limit is the diagonal straight line which connects the end points.

### **CAUTION**

The Goodman Curve applies only to fatigue-rated cells. Using it to calculate combined loadings on a standard load cell could result in damage to the cell.

In the example shown on the graph the dashed line indicates a situation where we want to apply a fixed load of 70%, and we want to know how much dynamic load we can apply simultaneously. By taking a straight horizontal line at the “70% Static Load” level across to the limit line and then projecting downward from that intersection, we find that the intersection on the dynamic scale at “65% of Rated Fatigue Capacity.” This means that, on a 1000 lbf rated fatigue cell, we could apply a fixed load of 700 lbf combined with a dynamic load of 650 lbf peak in both modes.

Checking the graph, note that if we needed to apply a fixed load of 160%, we could still apply a dynamic load of 20% for a total load which varies between 140% (lower peak) and 180% (upper peak). This would mean that the cell would be operating outside the limit of the normal factory calibration on fatigue cells of 100%. If the utmost accuracy is desired, it might be advisable to have a static calibration done on the cell up to 200%, which can be done on a fatigue-rated cell by special order.